

2016

A Methodology for Characterization of Vapor-injection Compressors

Fernando M. Tello Oquendo

Institute for Energy Engineering, Universitat Politècnica de València, Spain, fertelo1@upvnet.upv.es

Emilio Navarro-Peris

Institute for Energy Engineering, Universitat Politècnica de València, Spain, emilio.navarro@iie.upv.es

José González-Maciá

Institute for Energy Engineering, Universitat Politècnica de València, Spain, jgonzalv@ter.upv.es

Follow this and additional works at: <http://docs.lib.purdue.edu/icec>

Tello Oquendo, Fernando M.; Navarro-Peris, Emilio; and González-Maciá, José, "A Methodology for Characterization of Vapor-injection Compressors" (2016). *International Compressor Engineering Conference*. Paper 2424.
<http://docs.lib.purdue.edu/icec/2424>

This document has been made available through Purdue e-Pubs, a service of the Purdue University Libraries. Please contact epubs@purdue.edu for additional information.

Complete proceedings may be acquired in print and on CD-ROM directly from the Ray W. Herrick Laboratories at <https://engineering.purdue.edu/Herrick/Events/orderlit.html>

A Methodology for Characterization of Vapor-injection Compressors

Fernando M. TELLO OQUENDO^{1*}, Emilio NAVARRO-PERIS¹, José GONZÁLVEZ-MACIÁ¹

¹Institute for Energy Engineering, Universitat Politècnica de València, Camino de Vera s/n, Valencia, 46022, Spain.

fertelo1@upvnet.upv.es, emilio.navarro@iie.upv.es, jgonzalv@ter.upv.es

Phone: +34 963 879 120

Fax: +34 963 879 126

* Corresponding Author

ABSTRACT

Vapor-injection compressor technology is being used in refrigeration systems and heat pumps working at large differences between evaporating and condensing temperatures. However, there are no published standards for the characterization of this kind of compressors. Calorimetric benches are widely used to characterize compressors, nevertheless, the calorimetric benches, as known, cannot be used directly to characterize vapor-injection compressors, since the refrigerant conditions at the injection port are defined by the injecting temperature and the intermediate pressure. In addition, these intermediate conditions depend critically on the way in which the injection is performed (economizer, flash tank, liquid injection, etc.). Therefore, the characterization process of this type of compressors is more complex. In this paper, a methodology for characterizing vapor-injection compressors is proposed. The method allows measurement of vapor-injection compressors in a typical calorimetric test bench after implementing some minor modifications in order to incorporate the injection line. With these modifications, the system is capable of independently controlling the intermediate pressure and the injection temperature. The proposed methodology has been evaluated with a vapor-injection scroll compressor (of 17.1 m³/h) using R407C as a refrigerant. The measurement results and the performance parameters of the vapor-injection scroll compressor are presented. A simple correlation to estimate the injection mass flow rate as a function of the intermediate pressure has been found, that can be used to correlate the experimental results with high accuracy for several operating conditions. The advantages of the proposed methodology are the better control of the intermediate compression conditions and the possibility of testing vapor-injection compressors in a wide range of operating conditions.

1. INTRODUCTION

Cooling systems and heat pumps present several limitations working at high-pressure ratios: high compressor discharge temperature, cooling/heating capacity loss, rapid decrease of the COP and the like (Bertsch and Groll, 2008). A common solution is a two-stage compression with vapor-injection. The important advantages of this type of compression are the capacity improvement in severe climates; the system capacity can be varied by controlling the injected refrigerant mass flow rate, which permits energy savings by avoiding the intermittent operation of the compressor and the compressor discharge temperature is lower than that of a conventional single-stage cycle (Xu *et al.*, 2011).

To our best knowledge, there are no published standards for characterization of vapor-injection compressors. However, several recent research have been developed about vapor-injection compressors; most of them mainly focused on the experimental study of the heat pump system with economizer using vapor-injection scroll compressors (Bertsch and Groll, 2008), (Ma *et al.*, 2003), (Ding *et al.*, 2004), (Ma and Chai, 2004), (Wang *et al.*, 2009a), and (Wang *et al.*, 2009b). Regarding compressor characterization, Navarro *et al.* (2013) presented a test campaign of a vapor-injection scroll compressor considering a wide range of nominal operating conditions. The system used was air to water refrigerant injection circuit installed in a climatic chamber. The economizer was

composed of three heat exchangers in order to adjust the economizer size. The intermediate superheat was defined by the intermediate pressure and by the economizer size (UA).

In Europe, manufacturers characterize single-stage compressors based on the Standard UNE-EN 13771-1 (2003). The standard proposes several procedures for testing compressors. These procedures require the definition of three external conditions: evaporating pressure, condensing pressure and superheat at the compressor inlet. In these conditions, the mass flow rate and the power consumption have to be measured. The characterization of vapor-injection compressors is more complex because there are two additional degrees of freedom, the intermediate pressure, and the injection temperature. These parameters depend on how the system is designed internally, that is the way in which the injection is performed (economizer, flash tank, liquid injection, etc.). For a full characterization of these compressors, it is necessary to measure the injection mass flow rate.

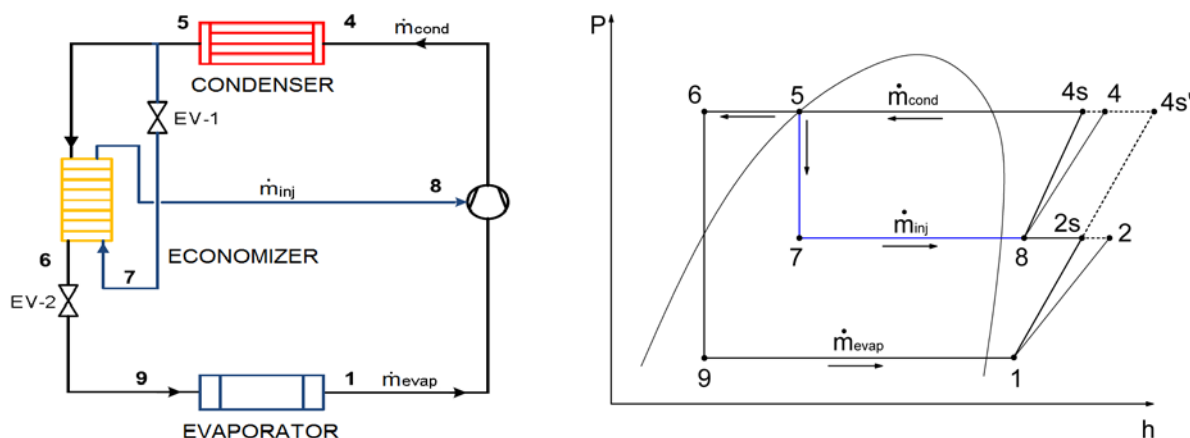

Figure 1: Schematic of a vapor-injection cycle with economizer and p-h diagram

For a given test matrix, when including the two additional parameters in the system, the number of experimental points increase considerably because the intermediate pressure can take several values for each operating point. However, not all points of the resultant test matrix describe the behavior of the compressor working in real operating conditions, since the compressor only works with a single intermediate pressure when the injection mechanism is set (injection cycle and control algorithm).

Figure 1 shows one of the most typical vapor-injection cycles. The system uses a heat exchanger (economizer) to vaporize the injection mass flow rate. The intermediate conditions are set from the economizer size and the chosen mechanism of control, which is usually a thermostatic expansion valve. Therefore, in this configuration, for each compressor size, a determined heat exchanger size has to be selected to define the different operating points of the compressor, which means having a set of heat exchangers (economizers) to characterize the compressor, hence the costs of the test bench increases dramatically.

In several compressor catalogs, the vapor-injection compressors are characterized considering a superheat at the compressor inlet of 5K; an injection superheat of 5K and a temperature approach in the economizer ($T_6 - T_7$ in Figure 1) of 5K. Therefore, for each operating point, many heat exchangers are needed in testing in order to maintain the temperature approach in the economizer.

This paper presents a methodology for characterization of vapor-injection compressors using a calorimetric bench. For the characterization, a system with economizer was simulated (see Figure 1). The economizer effect in the system is defined by the temperature approach in the economizer ($T_6 - T_7$). Fixing of this temperature approach is equivalent to set the economizer size. When the temperature approach in the economizer is set, it is possible to find a single intermediate pressure for each operating point (evaporating temperature, condensing temperature and superheat); therefore, the number of test points can be reduced dramatically. The advantages of the methodology are the better control of the intermediate compression conditions and the possibility of simulate several sizes of economizer, depending on the operating conditions.

2. EXPERIMENTAL SETUP

The compressor rating procedure was performed according to the European Standard UNE-EN 13771-1. Based on this standard, the refrigerant mass flow rate is the determining parameter to be measured, and primary and confirming measurements have to be made. The primary test procedure chosen is the secondary refrigerant calorimeter method. A Coriolis-type mass flow meter was used as the confirming test method. In all cases, confirming tests were carried out simultaneously with the primary mass flow rate determination.

Figure 2 shows the scheme of the calorimetric bench used for the compressor characterization.

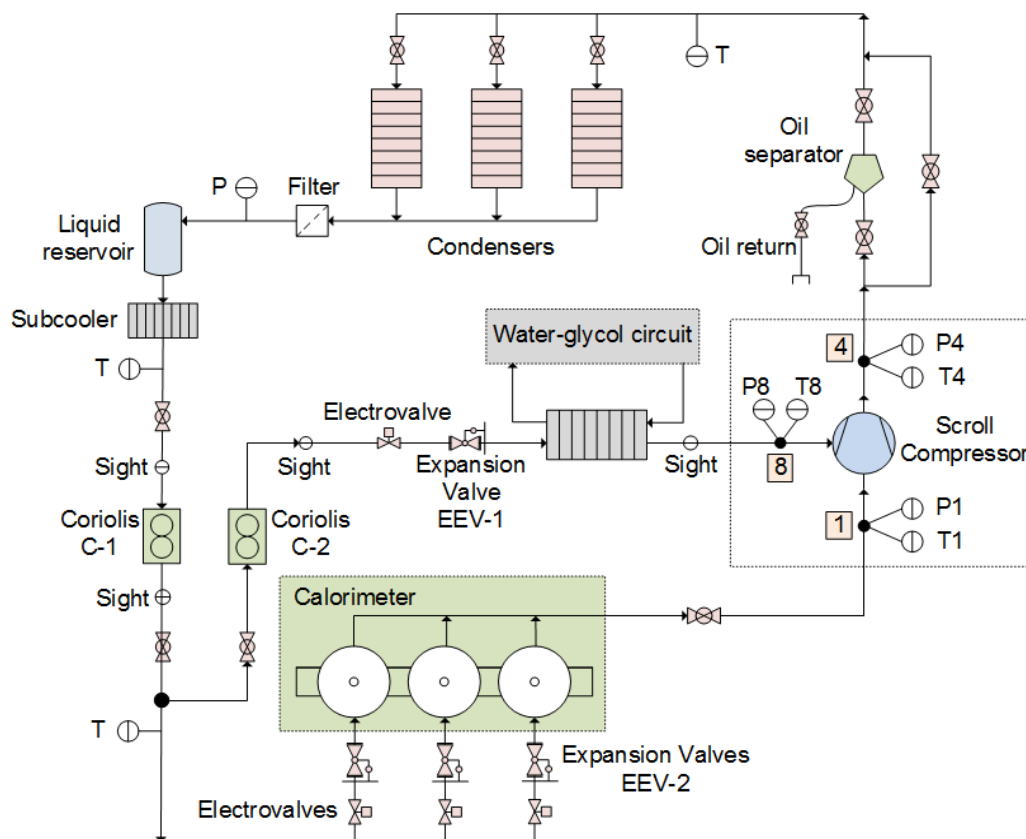

Figure 2: Calorimetric bench schematic

The condenser mass flow rate is directly measured using a Coriolis-type (Fisher–Rosemount Micro-Motion CMF025M), C-1 in Figure 2. Several PID control loops were incorporated to allow a precise adjustment of the refrigerant conditions at compressor inlet (evaporating temperature and superheat) and outlet (condensing temperature) with a precision of 1 kPa. The calorimetric bench is fully automated, and designed to reach any allowable test conditions without manual adjustments. The instrument accuracies of pressure transmitter (Fisher–Rosemount 3051) and temperature transmitter (RTD-PT 100) are 0.02% and 0.05°C, respectively.

In order to test the vapor-injection compressors, the calorimetric bench was modified to simulate the injection conditions and the interaction with the economizer. Part of the liquid (injection mass flow rate) is derived from the condenser outlet and is expanded to the intermediate pressure in an expansion valve (EEV-1 in Figure 2). After the expansion valve, the injection mass flow rate is vaporized in a heat exchanger using a secondary circuit of a water-glycol mixture. Electric resistors control the temperature of the water-glycol mixture in order to fix the injection superheat. With this arrangement, the system is capable of independently controlling the intermediate pressure and the injection temperature. The injection line is also equipped with a Coriolis-type mass flow meter with uncertainty of ± 0.025 g/s (C-2 in Figure 2), a pressure transducer with a precision of 0.2%, a RTD with a precision of 0.1K, visors and an electrovalve located before the expansion valve (EEV-1 in Figure 2).

The evaporator mass flow rate is calculated with equation (1) and is compared with the secondary refrigerant calorimeter based result.

$$\dot{m}_{\text{evap}} = \dot{m}_{\text{cond}} - \dot{m}_{\text{inj}} \quad (1)$$

The calorimetric bench was designed to control the operating conditions of the vapor-injection compressor at the points: (1), (4) and (8) (see calorimetric bench schematic in Figure 2). The compressor used for the characterization was a vapor-injection scroll compressor (SCVI), model ZH18KVE-TFD of 17.1 m³/h (swept volume). The SCVI was tested with R407C as a refrigerant.

3. CHARACTERIZATION PROCEDURE

In vapor-injection cycles with economizer (see Figure 1), for a given compressor size, the intermediate pressure is defined by the heat transfer in the economizer once the injection superheat is supplied. Therefore, for a given pressure ratio and an economizer size (UA), the intermediate pressure and the injection mass flow rate are fixed.

In the proposed calorimetric bench configuration (see Figure 2), there is no economizer because the evaporator mass flow rate does not interact with the injection mass flow rate into a heat exchanger. Therefore, to characterize the compressor, the working conditions of a real economizer cycle will be reproduced with the calorimetric bench using the following methodology.

The main objective of the methodology is to determine the corresponding intermediate pressure in order to have an injection mass flow rate. This injection mass flow rate must be able to produce a heat transfer in the virtual economizer which allows maintaining a temperature approach ($T_6 - T_7$) of 5K (see Figure 1). In that sense, this configuration would be equivalent to set the real economizer size, which would have in these working conditions.

The procedure of characterization begins with the setting of the condensing pressure, evaporating pressure and the superheat at the evaporator outlet acting on the flow rate of the water condenser, valves EEV-2 and resistors of the calorimeter, respectively. The intermediate pressure is regulated by the electronic expansion valve (EEV-1). The injection superheat is fixed with the water-glycol temperature through a heat exchanger. An injection superheat of 5K was chosen for testing, since in the majority of systems, the intermediate pressure control is performed with a thermostatic expansion valve. This valve needs a minimum superheat to regulate properly and to ensure that no liquid is injected, therefore, an intermediate superheat of 5K is appropriate. Furthermore, the injection superheat should be as low as possible to reduce the discharge temperature of the compressor. For all evaporating and condensing temperatures, the values of the considered parameters in the characterization are the superheat at the compressor inlet of 5K and the injection superheat of 5K. The cooling capacity and the COP are reported with a subcooling of 0K.

At this point, the injection mass flow rate and the intermediate pressure with which the compressor will work are not known. Thus, the methodology proposes an iterative process in order to find the intermediate conditions. The iterative process involves the progressive change of the intermediate pressure. The iterations end when the resultant injection mass flow rate produces a temperature approach of 5K in the virtual economizer of the cycle.

The iterative process begins by setting a starting intermediate pressure equal to the geometric mean of the evaporating and condensing pressures. Once the system is in equilibrium, the total mass flow rate (\dot{m}_{cond}), the injection mass flow rate (\dot{m}_{inj}), the injection temperature (T_8) and the condenser outlet temperature (T_5) are measured. The thermophysical properties of the refrigerant at points (5), (7) and (8) of Figure 1, are calculated with the NIST database (Lemmon *et al.*, 2010), and the evaporator mass flow rate is obtained from equation (1).

In the simulated cycle with an economizer (Figure 1), there is a heat exchange between the injection mass flow and the mass flow through the evaporator. Therefore, the following energy balance must be verified:

$$Q_{\text{econo}} = \dot{m}_{\text{inj}} \cdot (h_8 - h_7) = \dot{m}_{\text{evap}} \cdot (h_5 - h_6) \quad (2)$$

where Q_{econo} represents the economizer capacity; h represents the enthalpy corresponding to the different points described in the schematic of the vapor injection cycle of Figure 1. Solving the equation (2) the enthalpy and the temperature at the point (6) are calculated. At this point, the temperature approach in the economizer ($T_6 - T_7$) must be verified. If the temperature approach is 5K, then we have found the intermediate pressure for those working conditions. Otherwise, it must assume another value of intermediate pressure, and the iterative process is repeated. The new intermediate pressure (P_{int}^*) is calculated assuming a constant injection ratio ($X_{\text{inj}} = \dot{m}_{\text{inj}}/\dot{m}_{\text{evap}}$) and a temperature approach in the economizer of 5K. All the iterative process is represented in detail in the flowchart of Figure 3.

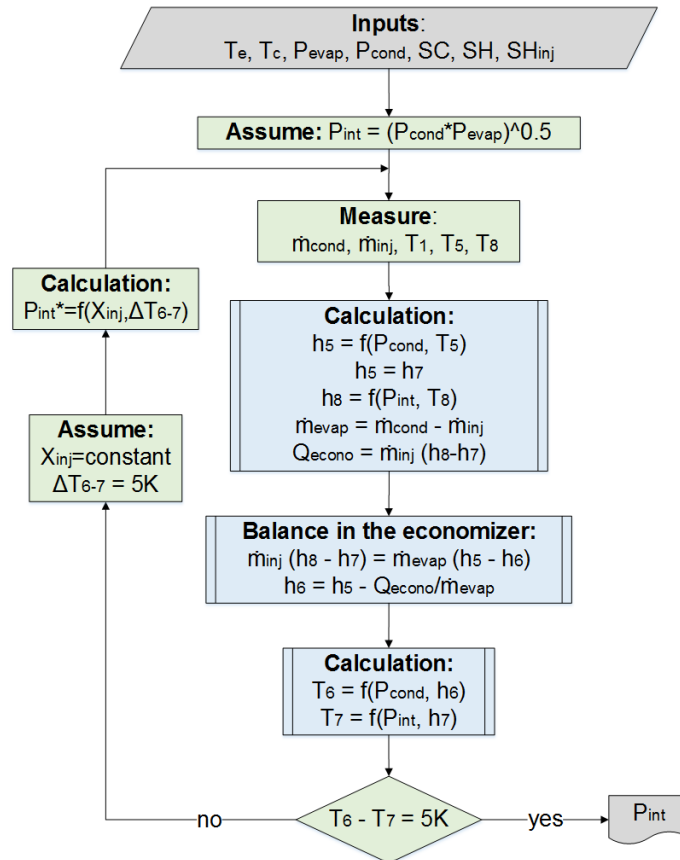

Figure 3: Flowchart for determining the intermediate conditions in a vapor-injection cycle with an economizer

4. RESULTS AND DISCUSSION

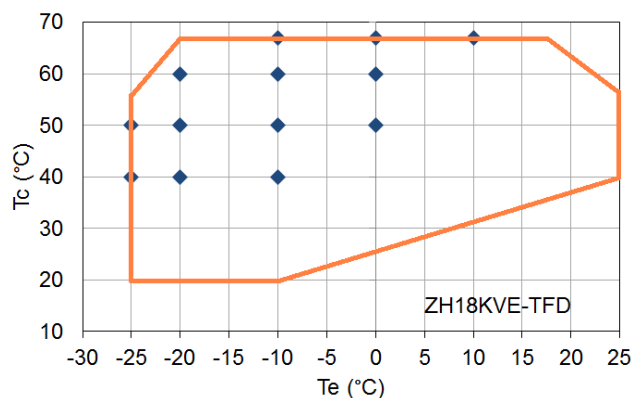

Figure 4: Working envelope and test matrix of the vapor-injection scroll compressor

Using the proposed methodology, vapor-injection compressors can be measured under the conditions of superheat at compressor inlet of 5K, injection superheat of 5K and temperature approach in the economizer of 5K. The methodology described above was applied to characterize a vapor-injection scroll compressor ZH18KVE-TFD at several working conditions. Figure 4 shows the working envelope of the compressor and the test matrix.

Table 1 shows the results of the compressor characterization working at evaporating temperature of -10°C and a condensing temperature of 60°C with a superheat at the compressor inlet of 5K. This table illustrates the iterative process shown in Figure 3 including all the performed iterations.

Table 1: Results of the compressor characterization working at the point (-10°C , 60°C)

P_{int} (kPa)	\dot{m}_{evap} (kg/s)	\dot{m}_{inj} (kg/s)	T_5 ($^{\circ}\text{C}$)	T_8 ($^{\circ}\text{C}$)	$h_5 = h_7$ (kJ/kg)	h_8 (kJ/kg)	\dot{Q}_{econo} (kW)	h_6 (kJ/kg)	T_6 ($^{\circ}\text{C}$)	T_7 ($^{\circ}\text{C}$)	$T_6 - T_7$ ($^{\circ}\text{C}$)
843.18	0.05412	0.02581	55.85	22.88	287.53	422.31	3.48	223.24	16.03	14.71	1.33
780.33	0.05381	0.02269	55.85	21.10	287.52	422.00	3.05	230.81	21.17	12.21	8.96
792.42	0.05395	0.02331	55.85	21.47	287.52	422.08	3.14	229.39	20.21	12.70	7.51
803.90	0.05404	0.02388	55.85	22.04	287.52	422.40	3.22	227.93	19.23	13.16	6.06
812.67	0.05369	0.02428	55.85	22.38	287.52	422.54	3.28	226.46	18.23	13.51	5.01

Normally, it is necessary to make 5 iterations for each operating point. The intermediate pressure as a function of the temperature approach in the economizer is plotted in Figure 5; it can be seen that the temperature approach shows a linear dependence with the intermediate pressure. This fact can be an advantage at the time of reducing the number of iterations of intermediate pressure required to reach a temperature approach of 5K in the economizer. Therefore, for other working points, it will be necessary to iterate twice to get a linear equation relating the intermediate pressure with the temperature approach. With this equation, it is possible to estimate the desired intermediate pressure in the third iteration.

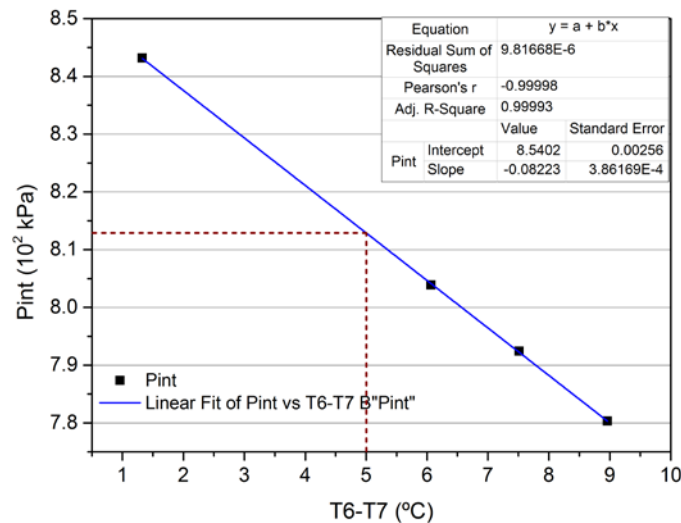

Figure 5: Intermediate pressure as a function of the temperature approach in the economizer, point (-10°C , 60°C)

Once the intermediate compression conditions are known, the cooling and heating capacity, the COP and the efficiencies are calculated. The volumetric and compressor efficiencies are defined by the equations (3) and (4) respectively. The results are shown in Table 2.

$$\eta_v = \frac{\dot{m}_{\text{evap}}}{\rho_1 \times \dot{V}_1} \quad (3)$$

$$\eta_c = \frac{\dot{m}_{\text{evap}}(h_{4s'} - h_1) + \dot{m}_{\text{inj}}(h_{4s} - h_8)}{P_a} \quad (4)$$

Table 2: Compressor performance parameters for the point (-10°C, 60°C)

Q _c (kW)	Q _h (kW)	P _a (kW)	COP _c	COP _h	η _c	η _v
9.802	15.975	6.441	1.522	2.480	0.544	0.840

In the iterative process, the linear dependence between the intermediate pressure and temperature approach in the economizer was verified for all measured points; however, the adjustment coefficients of the resulting linear equation are different for each operating point. Table 3 shows the results of the compressor characterization for each working condition of the test matrix (Figure 4).

Table 3: Compressor performance parameters at several working conditions

T _e (°C)	T _c (°C)	P _a (kW)	Q _h (kW)	Q _c (kW)	COP _h	COP _c	P _{econo} (kW)	\dot{m}_{evap} (kg/s)	\dot{m}_{inj} (kg/s)	P _{int} (kPa)	P _{evap} (kPa)	P _{cond} (kPa)	η _c	η _v
-25	40	3.817	9.762	6.206	2.557	1.626	1.731	0.03016	0.01082	390.15	172.84	1540.66	0.539	0.849
-20	40	3.978	11.461	7.695	2.881	1.935	1.948	0.03799	0.01202	456.86	215.03	1540.28	0.570	0.869
-10	40	4.280	15.362	11.252	3.589	2.629	2.291	0.05720	0.01380	607.42	319.87	1544.96	0.606	0.895
-25	50	4.600	10.174	5.861	2.212	1.274	2.010	0.02931	0.01386	455.38	173.34	1987.80	0.512	0.823
-20	50	4.805	11.781	7.213	2.452	1.501	2.276	0.03679	0.01548	525.27	215.08	1987.15	0.543	0.841
-10	50	5.234	15.660	10.644	2.992	2.033	2.839	0.05581	0.01879	697.36	320.35	1988.08	0.587	0.872
0	50	5.502	20.325	15.012	3.694	2.728	3.144	0.08185	0.02033	885.11	461.50	1990.36	0.619	0.899
-20	60	5.846	12.252	6.710	2.096	1.148	2.577	0.03568	0.01964	615.67	215.19	2527.89	0.505	0.815
-10	60	6.441	15.975	9.802	2.480	1.522	3.278	0.05369	0.02428	812.67	320.02	2528.32	0.544	0.840
0	60	6.827	20.520	13.920	3.006	2.039	3.868	0.07938	0.02795	1027.30	461.25	2528.52	0.587	0.871
-10	67	7.480	16.228	9.082	2.170	1.214	3.523	0.05168	0.02869	911.51	320.15	2972.13	0.504	0.808
0	67	8.030	20.569	12.839	2.562	1.599	4.246	0.07604	0.03370	1149.98	461.83	2972.30	0.541	0.835
10	67	8.318	25.723	17.693	3.092	2.127	4.883	0.10872	0.03798	1409.89	645.18	2971.81	0.577	0.859

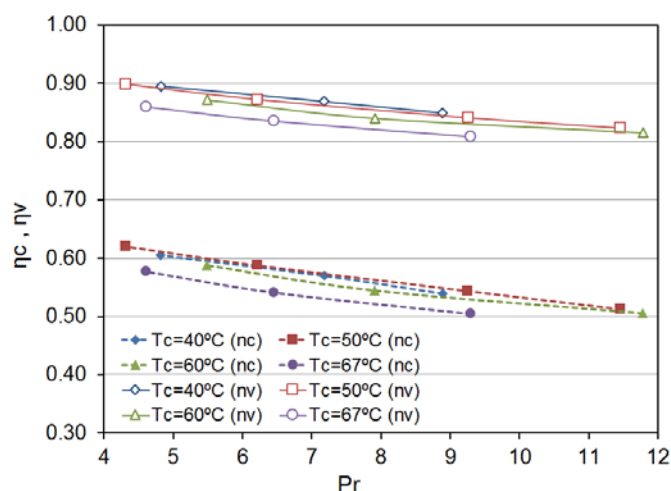

Figure 6: Compressor efficiency and volumetric efficiency as a function of pressure ratio at several condensing temperatures

Figure 6 depicts the compressor and volumetric efficiency of the SCVI as a function of the pressure ratio for several condensing temperatures. At lower condensing temperatures, the compressor efficiency, and volumetric efficiency are higher. The SCVI presents high volumetric efficiency values (above 0.8) for any operating point, because the compressor doesn't have undesirable dead space and no inlet and outlet valves, the contact between the flanks of scrolls and their bases and upper edges is almost perfect and constant; thus, it has very good axial and radial compliance. The compressor efficiency varies from 0.5 to 0.62. At lower condensing temperatures (40°C), the compressor efficiency is greater and for higher condensing temperatures and pressure ratios (around 12), the compressor efficiency decreases to 0.5.

Figure 7 illustrates the heating capacity (a) and the heating COP (b) as a function of evaporating temperature for several condensing temperatures. At low condensing temperatures, the COP_h is higher since the temperature focuses are closer. For a given evaporating temperature, the COP_h decreases as the condensing temperature increases, since the pressure ratio is greater and the compressor efficiency is reduced as seen in Figure 6. For a given condensing temperature, the heating capacity and the COP_h decrease when the compressor works with lower evaporating temperatures.

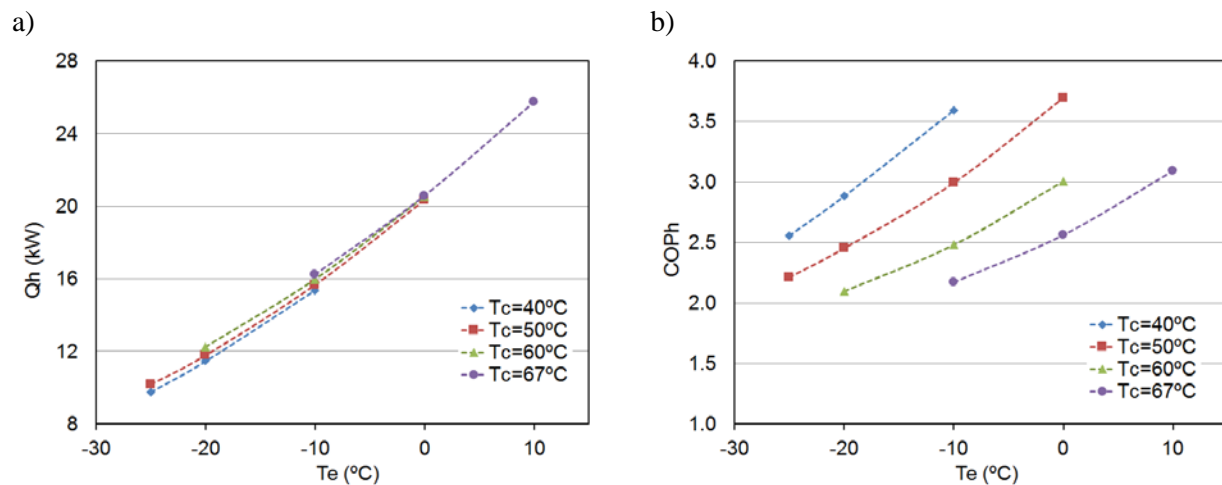

Figure 7: a) Heating capacity as a function of evaporating temperature. b) Heating COP as a function of evaporating temperature at several condensing temperatures

4.1 Injection mass flow rate correlation

In the compressor characterization process, the number of iterations is a very important factor, which should be minimized. One way of minimizing the number of iterations is using a cycle model to estimate the intermediate conditions. Because this type of cycle has two additional degrees of freedom (the intermediate pressure and the injection mass flow rate), it is necessary to have an expression that relates these two parameters to close the system.

Figure 8 represents the evolution of the injection ratio ($\dot{m}_{inj}/\dot{m}_{evap}$) to the pressure ratio (P_{int}/P_{evap}). This figure shows a linear tendency between the both plotted ratios. Based on Figure 8, the injection mass flow rate can be correlated with the intermediate pressure. The correlation is presented in equation (5). By linear regression, the coefficients A and B are obtained with a correlation factor higher than 0.99.

$$\frac{\dot{m}_{inj}}{\dot{m}_{evap}} = A + B \frac{P_{inj}}{P_{evap}} \quad (5)$$

$$A = -0.366; B = -0.322$$

To define the correlation at least 12 points of the compressor working envelope have been measured. Once the correlation is defined, the intermediate pressure can be calculated directly for different working conditions. Consequently, the time required to characterize a compressor is dramatically reduced.

The compressor manufacturer should provide this kind of correlations in order to define the intermediate conditions depending on the working conditions.

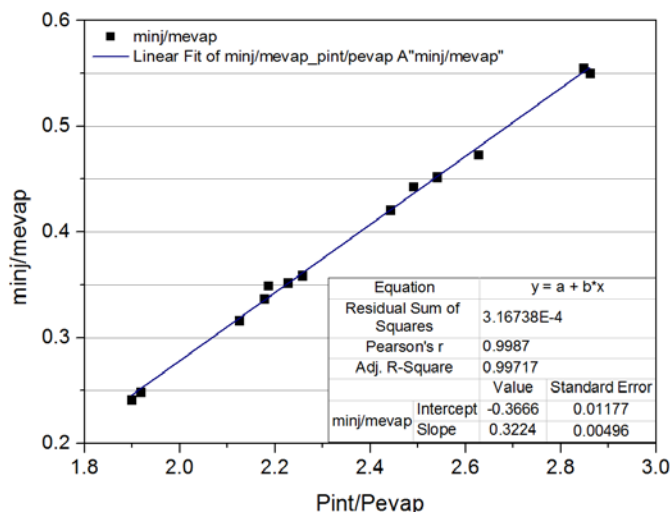

Figure 8: Injection ratio ($\dot{m}_{inj}/\dot{m}_{evap}$) as a function of the pressure ratio (P_{int}/P_{evap})

6. CONCLUSIONS

A methodology of characterization for vapor-injection compressors is proposed. This procedure is performed in a typical calorimetric bench with minor modifications in order to incorporate the injection line. The system can control the intermediate conditions (intermediate pressure and injection superheat) independently.

The intermediate pressure is calculated with an iterative process until the resulting injection mass flow rate produces a temperature approach in the economizer of 5K. A linear dependence between the intermediate pressure and the temperature approach in the economizer is found, which reduces the number of iterations.

With the proposed methodology, a vapor-injection scroll compressor was characterized in a wide range of operating conditions. A simple correlation to estimate the injection mass flow rate as a function of the intermediate pressure has been found, and it is able to correlate the experimental results with high accuracy for several operating conditions. This correlation can be used for modeling the cycle and to define easily the intermediate conditions.

The advantages of the proposed methodology are the better control of the intermediate compression conditions and the possibility of testing vapor-injection compressors in a wide range of operating conditions with no need of having heat exchangers (economizers) of different sizes for each working point; therefore, the costs of the test bench are reduced dramatically.

NOMENCLATURE

COP	coefficient of performance	(-)
h	enthalpy	(kJ/kg)
\dot{m}	mass flow rate	(kg/s)
P	pressure	(kPa)
P_a	compressor consumption	(kW)
P_r	pressure ratio	(-)
Q_c	cooling capacity	(kW)
Q_{econo}	economizer capacity	(kW)
Q_h	heating capacity	(kW)
SC	subcooling	(°C)

SCVI	scroll compressor with vapor-injection	
SH	superheat	(°C)
T	temperature	(°C)
Greek symbols		
ρ	density	(kg/m ³)
η_c	compressor efficiency	(-)
η_v	volumetric efficiency	(-)

Subscript

c	condensing
cond	condenser
e	evaporating
econo	economizer
evap	evaporator
inj	injection
int	intermediate
s	isentropic
1	compressor inlet

REFERENCES

- Bertsch, S. & Groll, E. (2008). Two-stage air-source heat pump for residential heating and cooling applications in northern U.S. climates. *Int. J. Refrig.*, 31, 1282-1292.
- Ding, Y., Chai, Q., Ma, G., & Jiang, Y. (2004). Experimental study of an improved air source heat pump, *Energ. Convers. Manage.*, 45, 2393-2403.
- Lemmon, E., Huber, M., & McLinden, M., (2010). NIST Standard Reference Database 23: Reference Fluid Thermodynamic and Transport Properties-refprop. Version 9.0., *National Institute of Standards and Technology*, Standard Reference Data Program, Gaithersburg.
- Ma, G., Chai, Q., & Jiang, Y. (2003). Experimental investigation of air-source heat pump for cold regions, *Int. J. Refrig.*, 26, 12-18.
- Ma, G., & Chai, Q. (2004). Characteristics of an improved heat-pump cycle for cold regions, *Appl. Therm. Eng.*, 77, 235-247.
- Navarro, E., Redón, A., González, J., & Martínez, I. (2013). Characterization of a vapor injection scroll compressor as a function of low, intermediate and high pressures and temperature conditions, *Int. J. Refrig.*, 36, 1821-1829.
- UNE-EN 13771-1. (2003). Compressors and condensing units for refrigeration – Performance testing and test methods.
- Wang, B., Shi, W., Han, L., & Li, X. (2009a). Optimization of refrigeration system with gas-injected scroll compressor, *Int. J. Refrig.*, 32, 1544-1554.
- Wang, X., Hwuang, Y., & Radermacher, R. (2009b). Two-stage heat pump system with vapor-injected scroll compressor using R410A as a refrigerant, *Int. J. Refrig.*, 32, 1442-1451.
- Xu, X., Hwang, Y., & Radermacher, R. (2011). Refrigerant injection for heat pumping/air conditioning systems: literature review and challenges discussions, *Int. J. Refrig.*, 34, 402-415.

ACKNOWLEDGEMENT

Fernando M. Tello Oquendo acknowledges the financial support provided by the “CONVOCATORIA ABIERTA 2013-SEGUNDA FASE” program, which was funded by the SENESCYT (“Secretaría Nacional de Educación Superior, Ciencia, Tecnología e Innovación”) (Grand No 2015-AR37665) of Ecuador.