

2008

Study on Performance Evaluation Method of a Split Air Conditioning System Based on Characteristic Curve of the Compressor Mass Flow Rate

Shinichi Takahashi

Tokyo University of Marine Science and Technology

Shigeru Tokita

Public Buildings Association

Masayasu Itou

Ministry of Land

Akio Funatani

Osaka Gas Co.

Shigeki Kametani

Tokyo University of Marine Science and Technology

Follow this and additional works at: <http://docs.lib.purdue.edu/iracc>

Takahashi, Shinichi; Tokita, Shigeru; Itou, Masayasu; Funatani, Akio; and Kametani, Shigeki, "Study on Performance Evaluation Method of a Split Air Conditioning System Based on Characteristic Curve of the Compressor Mass Flow Rate" (2008). *International Refrigeration and Air Conditioning Conference*. Paper 1005.
<http://docs.lib.purdue.edu/iracc/1005>

This document has been made available through Purdue e-Pubs, a service of the Purdue University Libraries. Please contact epubs@purdue.edu for additional information.

Complete proceedings may be acquired in print and on CD-ROM directly from the Ray W. Herrick Laboratories at <https://engineering.purdue.edu/Herrick/Events/orderlit.html>

Study on Performance Evaluation Method of a Split Air Conditioning System Based on Characteristic Curve of the Compressor Mass Flow Rate

*Shinichi Takahashi¹, Shigeru Tokita², Masayasu Itou³, Akio Funatani⁴, Shigeki Kametani⁵

¹Tokyo University of Marine Science and Technology
4-5-7, Konan, Minato, 108-8477 Tokyo, Japan
*(81-3-5463-0492, 81-3-5463-0492, m074005@kaiyodai.ac.jp)

²Public Buildings Association
1-24-8, Shinkawa, Chuo, 104-0033 Tokyo, Japan
(03-3523-0381, 03-3523-1826, tokita@pba.or.jp)

³Ministry of Land, Infrastructure and Transport Government of Japan
2-1-3, Kasumigaseki, Chiyoda, 100-0013 Tokyo, Japan
(03-5253-8247, 03-5253-1545, itou-m2e4@mlit.go.jp)

⁴Osaka Gas Co., Ltd., Department of gas energy
2-2-1, Otemachi, Chiyoda, 100-0004 Tokyo, Japan
(81-3-3272-4732, 81-3-3272-4735, funatani@osakagas.co.jp)

⁵Tokyo University of Marine Science and Technology
4-5-7, Konan, Minato, 108-8477 Tokyo, Japan
(81-3-5463-0491, 81-3-5463-0491, kametani@kaiyodai.ac.jp)

ABSTRACT

This paper deals with the actual performance evaluation method of a split air conditioning system based on characteristics curve of the compressor mass flow rate. Generally, it is very difficult to evaluate the actual performance of a split air conditioning system, because the heat flux in an air blow unit is very complicated, measurement of the temperature and wind velocity is very difficult. Then, we examined how to evaluate performance, from both of the enthalpy difference and the refrigerant mass flow rate which circulate through a system. The test unit was a gas engine-driven heat pump split air conditioning system.

Regression equations for refrigerant mass flow rate were obtained based on characteristic curve of the scroll compressor. Cooling and heating capacity were given by multiplying the approximated mass flow rate by the differential of enthalpy pass the refrigerant piping mean the inside machine. The standard errors of the approximated mass flow rate from the measured values were within 0.05 kg/min. We compared the calculated mass flow rate with the previous detail data in order to verify these equations. Then the relative errors of the calculated from the measured values were within 2%.

1. INTRODUCTION

In recent years, the demand for a split air conditioning system in Japan has increased rapidly. In 2007, seven million air conditioning machines including residential use were shipped. These systems are installed in buildings which have a total floor area of 100,000 square meters because of high efficiency and ease of installation. However a performance evaluation method of these systems under the actual conditions hasn't been established yet.

In Japan, these systems are evaluated by JIS (Japan Industrial Standard) and JRA (The Japan Refrigeration and Air Conditioning Industry Association) rules. The performance tests are done in static conditions and it quite differs from the actual condition. Because of these tests can't evaluate the performance under a part load. So we think an actual performance evaluation method is necessary.

With these things as background, the actual performance and energy consumption were clarified by the experiments (Yumoto et al., 2006). The result of this experiment, the measured coefficient of performance (COP) is lower than

the rated COP in all operation. The causes of this result are the defrosting operation and on-off control. These operations decrease the COP drastically.

On the other hand, it is developed the performance evaluation method measuring the heat flux (Yumoto et al., 2006). They measured a thermal capacity of a split system from a heat flux on air outlet. But in this method it is so hard to measure the gas engine-driven heat pump air conditioning systems (GHP). The major cause is a waste heat from gas engine cooling water contained a heat flux blowing out from outdoor unit. Secondly, it needs the engine efficiency to calculate the COP, and the practical method for GHP hasn't established yet.

We propose the performance evaluation method called the compressor curve method. This method is based on the characteristic curves of compressor mass flow rate. The discharge rate of the scroll compressor can be obtained as the product of volumetric efficiency, swept volume, suction refrigerant density and compressor revolution. Generally the compressor maker doesn't disclose these values, so we can not determine the value of mass flow rate accurately. But if the super heat of refrigerant is constant, volumetric efficiency and suction refrigerant density can be estimated from evaporating and condensing temperature. So we made regression equations of refrigerant mass flow rate that took evaporating and condensing temperatures as variables experimentally. Cooling and heating capacities were given by multiplying the approximated mass flow rate by the differential of refrigerant enthalpies pass the indoor unit.

2. EXPERIMENTAL METHOD AND EQUIPMENTS

2.1 Experimental Method

The measurement was done under the constant thermal conditions and gas engine revolution. Then we measured the cooling and heating capacities of test unit, the gas engine and compressor revolution, refrigerant temperatures, pressures and mass flow rate of test unit. The cooling and heating capacities of test unit are considered as the calories supplied to the test chambers. The refrigerant mass flow rate was measured with a coriolis mass flow meter. In this experiment, the expansion valves were controlled to keep subcool (5°C) and superheat temperature (8°C).

2.2 Experimental equipments

In this experiment, the room type calorimeter chamber which belongs to Tokyo Gas Co., Ltd. is used. These chambers are used for the performance test of air conditioning systems. They have the thermal buffer zone, and each chamber can control any dry and wet bulbs temperatures. The specifications of test chambers and a round sketch of the chambers are shown in Table 1 and Figure 1. The test machine has the one indoor and outdoor unit. The specifications of the test unit are shown in Table 2 and a piping diagram of the test unit is shown as Figure 2.

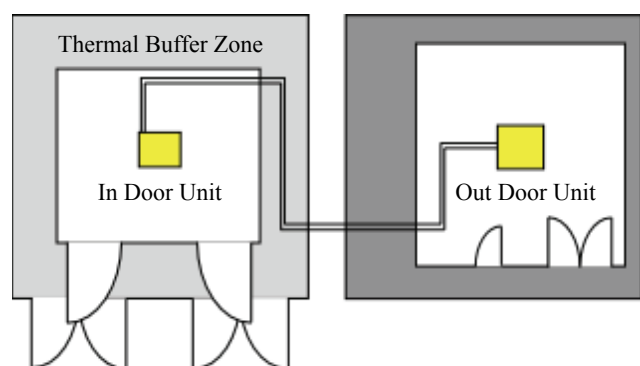

Figure 1: Round sketch of the test chambers

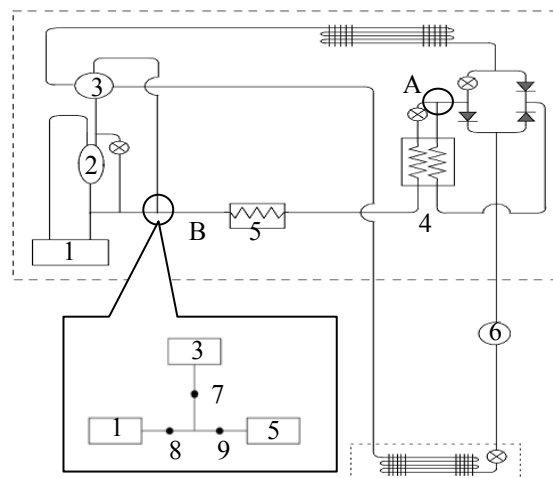

Figure 2: Piping diagram of the test unit: 1. scroll compressor, 2. oil separator, 3. four-way valve, 4. Subcooler, 5. Waste heat recovery system, 6. Coriolis mass flow mater, 7-9. Measurement points of refrigerant enthalpy, A. Brunch point, B. Confluence point.

Table 1: Specifications of test chambers

Designation		Specifications
Rooftop	Boiler	313.4 (kW)
	Refrigerator	19.1 (kW) × 8
Indoor Side	AHU1	65 (kW) (Cooling Capacity)
		40 (kW) (Heating Capacity)
		10,000 (m ³ /h) (Air Volume)
	AHU2	65 (kW) (Cooling Capacity)
		3,000 (m ³ /h) (Air Volume)
	Humidlifter	22.0 (kg/h)
Electric Heater	4.0 (kW)	
Outdoor Side	AHU	90.5 (kW) (Cooling Capacity)
		36.5 (kW) (Heating Capacity)
		30,000 (m ³ /h) (Air Volume)

Table 2: Specifications of a test unit

Designation	Specifications
Compressor Type	Scroll Compressor
Electric Source	3φ200V
Refrigerant	R410A
Cooling Capacity	14 (kW)
Heating Capacity	16 (kW)

2.3 Experimental conditions

This experiment was done under the cooling and heating conditions. Test conditions of dry and wet bulbs temperatures are shown in Table 3 and Table 4. The experimental measurement was done under a wide range operating conditions because of measuring the change in characteristics of compressor.

In this experiment, the gas engine revolution is controlled on 900, 1200, 1550 (rpm) in each conditions.

Compressor revolution increases in proportion to gas engine revolution. The revolution increasing ratio is 2.15. The measured values of compressor revolution are shown in Table 5.

Table 3: Test conditions of cooling operation

	In Door Side DB/WB (°C)	Out Door Side DB/WB (°C)
1	24/17	35/24
2	27/19	
3	30/21	
4	24/17	30/21
5	27/19	
6	24/17	25/17
7	27/19	

Table 4: Test conditions of heating operation

	In Door Side DB/WB (°C)	Out Door Side DB/WB (°C)
1	20	2
2	17	4
3	20	
4	23	
5	14	7
6	17	
7	20	
8	23	
9	17	9
10	20	
11	23	

Table 5: Gas engine and compressor revolution

Gas Engine Revolution (rpm)	Compressor Revolution (rpm)
900	1940
1200	2590
1550	3340

3. EXPERIMENTAL RESULTS AND DISCUSSION

3.1 Evaporating and Condensing Temperatures

In cooling operation, the evaporating temperature is considered as the saturation temperature at an outlet refrigerant pressure of indoor unit and the condensing temperature is considered as the saturation temperature at an outlet refrigerant pressure of outdoor unit.

In heating operation, the evaporating temperature is considered as the saturation temperature of an outlet refrigerant pressure of the evaporator and the condensing temperature is considered as the saturation temperature of an outlet refrigerant pressure of indoor unit. The physical properties of refrigerants were calculated with REFPROP7.0. The measured values of evaporating and condensing temperatures are shown in Fig. 3.

3.2 Refrigerant Mass Flow Rate

Refrigerant mass flow rate is measured with a coriolis mass flow meter. The test unit has a heat exchanger which is called subcooler. After passing through the condenser, refrigerant piping branches off at point A of Figure 2. Almost all refrigerant pass an evaporator and very little one do a subcooler.

In cooling operation, the thermal energy is exchanged between the refrigerant before the branch point and passing through the subcooler. The mass flow meter is attached after the branch point. So discharge rate of compressor is the total of evaporator and subcooler mass flow rate. The refrigerant mass flow rate pass through the subcooler can be calculated from the value of enthalpy at the confluence of two refrigerant piping (point B of Figure 2). The heat balance at the junction point is shown by equation (1). And equation (1) is rearranged as equation (2).

In heating operation, the heat energy is exchanged between the refrigerant goes to the evaporator and passing through the subcooler. The mass flow meter is attached before the branch point. So discharge rate of compressor is considered as the measured values of the mass flow rate.

On the other hand, the refrigerant separated in an oil separator is neglected because of small amount. The measurements of refrigerant mass flow rate are shown in Fig. 4.

$$(G_e + G_{sub}) \times h_8 = G_e \times h_7 + G_{sub} \times h_9 \quad (1)$$

$$G_{sub} = G_e \times \frac{h_7 - h_8}{h_8 - h_9} \quad (2)$$

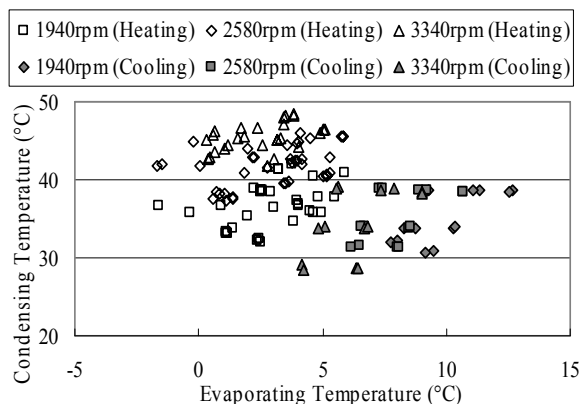

Figure 3: Evaporating and condensing temperatures

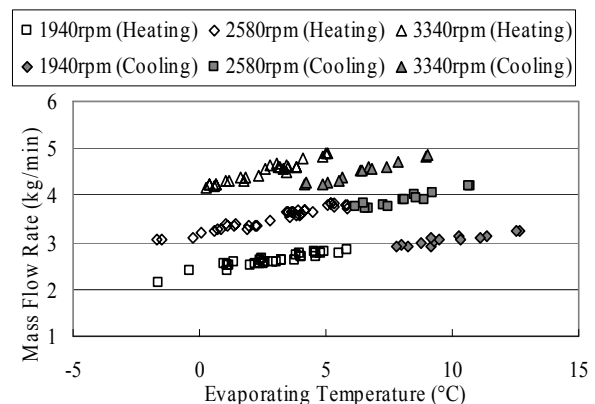

Figure 4: Measurements of refrigerant mass flow rate

3.3 Regression Equation

Regression equations of refrigerant mass flow rate are calculated using the least square method. These equations give the approximated values with a small error because of high partial determination coefficients and small standard errors of these regression equations. In cooling and heating operation, the regression equations, coefficient of determination and standard errors of estimate are shown in Table 6 and Table 7.

With the purpose of the regression curves are applied to a wide range of revolutions, regression equations of each partial regression coefficients that take compressor revolution are calculated. In cooling and heating operation, the regression equations, coefficient of determination and standard errors are shown in Table 8 and Table 9.

The regression curves are shown in Fig. 5 at condensing temperature 35°C and Fig. 6 at condensing temperature 40°C. The diagrams show an experimental value with dots and approximate value with lines.

Table 6: Regression equations of refrigerant mass flow rate in cooling

Compressor Revolution (rpm)	Regression Equation	Partial Determination Coefficient	Standard Error (kg/min)
1940rpm	$G_{comp} = 0.0850T_e - 0.0120T_c + 2.64$	0.896	0.038
2580rpm	$G_{comp} = 0.117T_e - 0.0100T_c + 3.31$	0.929	0.042
3340rpm	$G_{comp} = 0.145T_e - 0.00786T_c + 3.84$	0.979	0.031

Table 7: Regression equations of refrigerant mass flow rate in heating

Compressor Revolution (rpm)	Regression Equation	Partial Determination Coefficient	Standard Error (kg/min)
1940rpm	$G_{comp} = 0.0835T_e - 0.00832T_c + 2.68$	0.902	0.044
2580rpm	$G_{comp} = 0.117T_e - 0.0139T_c + 3.75$	0.960	0.046
3340rpm	$G_{comp} = 0.159T_e - 0.0297T_c + 5.45$	0.980	0.032

Table 8: Regression equations of partial regression coefficients in cooling

partial regression coefficients	Regression Equation	Partial Determination Coefficient	Standard Error (kg/min)
T_e term	$a = 4.30 \times 10^{-5} N + 0.00297$	0.988	0.038
T_c term	$a = 2.94 \times 10^{-6} N - 0.0176$	0.982	0.042
constant term	$a = 8.58 \times 10^{-4} N + 1.01$	0.975	0.031

Table 9: Regression equations of partial regression coefficients in heating

partial regression coefficients	Regression Equation	Partial Determination Coefficient	Standard Error (kg/min)
T_e term	$a = 6.06 \times 10^{-5} N + 0.0449$	0.995	0.038
T_c term	$a = -1.61 \times 10^{-5} N - 0.0252$	0.979	0.042
constant term	$a = 1.98 \times 10^{-3} N + 1.22$	0.995	0.031

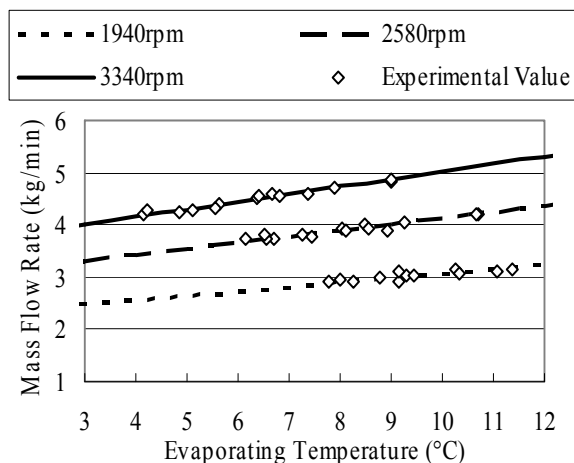

Figure 5: Regression curves of refrigerant mass flow rate in cooling (condensing temperature: 35°C)

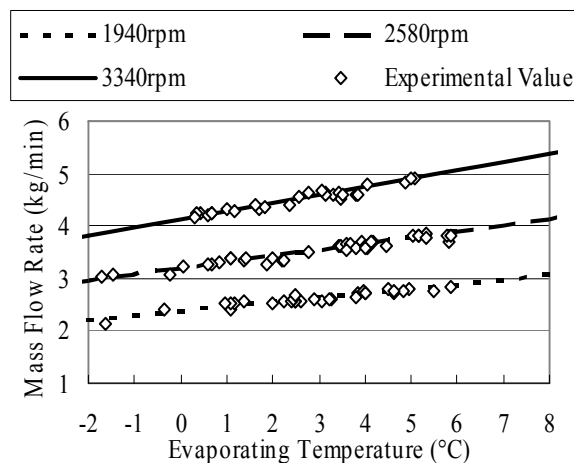

Figure 6: Regression curves of refrigerant mass flow rate in heating (condensing temperature: 40°C)

3.4 Cooling Capacity

Cooling and heating capacity were calculated by using the mass flow rate through the evaporator and the differential of refrigerant enthalpies on the indoor unit. In cooling operation, the mass flow rate through the evaporator can be obtained by subtracting the mass flow rate through the subcooler from the calculated values. The measured and calculated values of cooling capacity are shown in Fig. 7. The calculated values are similar to the measured ones. The relative errors of the calculated values from the measured values are within 6% in cooling operation. In heating operation, the calculated values aren't compared with measured ones because the measured heating capacities vary widely.

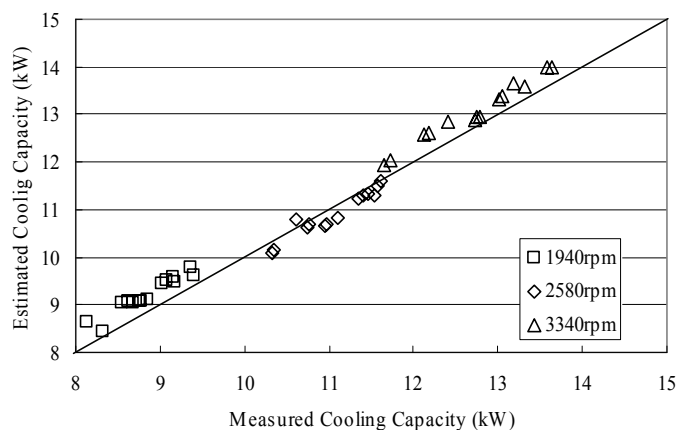

Figure 7: calculated and measured capacities

3.5 Verification of Equations

In order to verify these equations, the calculated mass flow rate compared with the previous detail experimental data. The test unit which was used in the previous experiment was the same unit in this test. The experiments were done under the cooling and heating conditions. In previous experiment, the gas engine revolution and the expansion valves aren't controlled. The data which were used verification are shown in Table 8. Refrigerant mass flow rate is calculated with the measured compressor revolution, evaporating temperature and condensing temperature. The compressor revolution is calculated using previous increasing ratio. The evaporating and condensing temperature is measured with thermo couples on the outlet of an evaporator and a condenser. These data were determined every 5 minutes. The relative errors of the calculated values from the measured values were at most 25% in cooling

operation, but in heating operation they were within 10%. The comparison of the experimental results with calculated ones are shown in Fig. 9 and Fig. 10. According to the data verification, the previous experimental results showed good agreement with the regression equations in heating operation. In these measurements, gas engine revolution was continually changing from 2580rpm to 2900rpm. Even changing the gas engine revolution, the relative errors of the calculated values from the measured ones were within 10%.

On the other hand, the relative errors of the calculated values from the measured ones are too large in cooling operation. The primary cause of these errors is the refrigerant mass flow rate through the subcooler was uncounted. The refrigerant mass flow rate calculated with the regression equations includes the refrigerant which passes through the subcooler. So the calculated values which are calculated with the regression equations are bigger than actual value. The error due to this cause is at most 10-odd percent. Therefore calculation of the refrigerant mass flow rate through the subcooler is indispensable.

Table 8: details of the previous detail data

No	Operating Condition	In Door Side DB/WB (°C)	Out Door Side DB/WB (°C)	Compressor Revolution (rpm)	Thermal Road (%)
1	Cooling	27/19	35/24	3120	100
2		24/17		3120	100
3		26/18		3120	100
4		27/19		3340	100
5		27/19		3340	100
6	Heating	20/15	7/6	1940	50
7		24/18		2580	100
8		24/18		2690	100
9		24/18		2800	100
10		24/18		2900	100
11		22/17		3120	100
12		20/15		3230	100

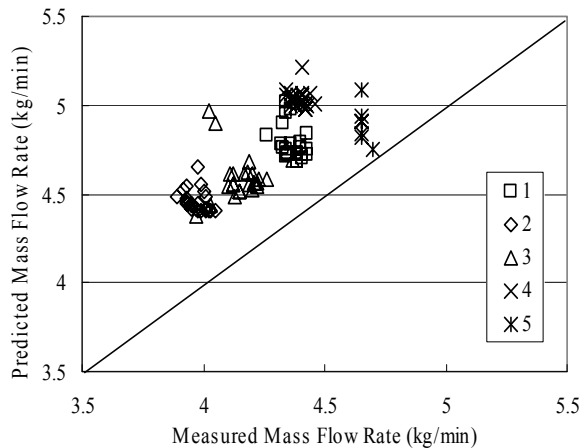

Figure 9: calculated and measured mass flow rate in cooling

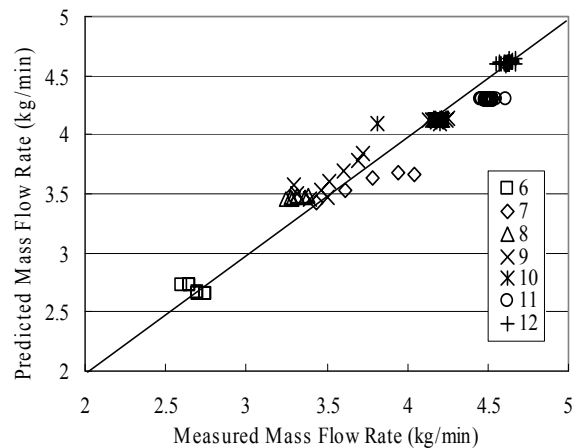

Figure 10: calculated and measured mass flow rate in heating

4. CONCLUSIONS

We performed an experiment in the GHP unit using the environmental test room, and the performance evaluation method based on the characteristic curve of the compressor was developed. The acquired knowledge is as follows.

- The regression equations are very close to the characteristic curve of compressor mass flow rate in precision. The relative errors of the calculated from the measured mass flow rate are within 5%.
- The capacity calculated with regression equations agree well with the measured one. The relative errors of the calculated cooling capacity from the measured values are within 6%.
- The verification of regression equations was done using the previous experimental data. In heating operation, the calculated values gave a good agreement with the previous data.
- In cooling operation the relative error was at most 25% because the refrigerant passing through the subcooler is unconsidered. Therefore calculation of the refrigerant mass flow rate though the subcooler is indispensable.
- Even the gas engine revolution changing continually, the relative errors of the calculated values from the measured values were within 10%.

For the above mentioned result, the significance of the developed evaluation method was checked. This method is applicable also to EHP (Electric-driven Heat Pump System) units. If this evaluation method is employed, we can know the actual performance of a split air conditioning system, i.e., efficiency and energy consumed.

NOMENCLATURE

G	refrigerant mass flow rate	(kg/min)	Subscripts	
h	enthalpy	(kJ/kg)	comp	compressor
T	temperature	(°C)	sub	subcooler
N	gas engine speed	(rpm)	e	evaporator
a	partial regression coefficient	(-)	c	condenser
			7-8	measure points of enthalpy (Fig. 2)

REFERENCES

- Yumoto, Y., Ichikawa, T., Nobe, T., Kametani, S., 2006, Study on Performance Evaluation of a Split Air Conditioning System Under the Actual Conditions, *Proc Int. Refrig. Conf. Purdue*: R067 p.1-8(CD-R)
- Yumoto, Y., Yanagihara, R., Ichikawa, T., Nobe, T., Kametani, S., 2006, Study on the Evaluation Method for Performance of an Unitary Air-conditioner in the Actual Conditions - Evaluating the Heat Flux from the Outdoor Unit -, *Trans. of the JSRAE*.: p. 111-114.
- Michio, N., Hiroyasu, Y., Kazuyasu, G., Mitsuki, M., 2006, Research on the Quantity-of-Heat Measurement for Multi-Split Type Air Conditioning System Performance Verification, *Trans. of the JSRAE*.: p. 1021-1024.
- Hideki, A., Shinichi, A., Jun, S., 2007, Study on the Performance of Household Air-Conditioner in the Practical Use, *J. Environ. Eng., AIJ*, no. 613: p. 35-40
- Shuangquan, S., Wenxing, S., Xianting, L., Huajun, C., 2004, Performance Representation of Variable-Speed Compressor for Inverter Air Conditioners Based on Experimental Data, *Int. J. Refrig.*, vol. 27, no. 8: p. 805-815.
- Japanese Standards Association, 1999, Ducted air-conditioners and air-to-air heat pumps Testing and rating for performance JIS B 8615-1, *Japanese Standard Association*: p. 2-42.
- Japanese Standards Association, 1999, Ducted air-conditioners and air-to-air heat pumps Testing and rating for performance JIS B 8615-2, *Japanese Standard Association*: p. 2-42.
- The Japan Refrigeration and Air Conditioning Industry Association, 2001, Calculating method of annual power consumption for package air conditioners JRA4048, *Japanese Standard Association*: p. 5-30.