

Purdue University

Purdue e-Pubs

International Refrigeration and Air Conditioning
Conference

School of Mechanical Engineering

2021

An Evaluation of the Effect of Corrosion Tests on Thermal Performance of Aluminum Heat Exchangers

Yupeng Wang

University of Illinois at Urbana-Champaign, yupeng2@illinois.edu

Hui Zhao

University of Illinois at Urbana-Champaign

Pega Hrnjak

University of Illinois at Urbana-Champaign

Follow this and additional works at: <https://docs.lib.purdue.edu/iracc>

Wang, Yupeng; Zhao, Hui; and Hrnjak, Pega, "An Evaluation of the Effect of Corrosion Tests on Thermal Performance of Aluminum Heat Exchangers" (2021). *International Refrigeration and Air Conditioning Conference*. Paper 2196.

<https://docs.lib.purdue.edu/iracc/2196>

This document has been made available through Purdue e-Pubs, a service of the Purdue University Libraries.

Please contact epubs@purdue.edu for additional information.

Complete proceedings may be acquired in print and on CD-ROM directly from the Ray W. Herrick Laboratories at <https://engineering.purdue.edu/Herrick/Events/orderlit.html>

An Evaluation of the Effect of Corrosion Tests on Thermal Performance of Aluminum Heat Exchangers

Yupeng WANG⁽¹⁾, Hui ZHAO^(1,2), Pega HRNJAK^(1,2,*)

¹University of Illinois at Urbana-Champaign
Department of Mechanical Science and Engineering
1206 West Green Street, Urbana, IL 61801, USA

²Creative Thermal Solutions, Inc.
2209 North Willow Road, Urbana, IL 61802, USA

* Corresponding author: pega@illinois.edu

ABSTRACT

This paper shows the impact of the external corrosion generated by SWAAT tests on the thermal performance of the aluminum heat exchangers. The SWAAT tests were designed to evaluate the durability of metallic materials, it could be further utilized to evaluate the effect of corrosion on the thermal and hydraulic performances. The accelerated corrosion test leaves a large amount of salt and corrosion products on the heat exchanger surface. These deposits do not usually occur in operating conditions (some fouling does), they could mislead the understanding of the real effect of corrosion on heat exchanger performance. This paper presents experiments with two identical brazed aluminum HXs being exposed to a series of salt spray corrosion tests (SWAAT): the airside pressure drop, the heat exchanger heat transfer characteristics, and the weight of the heat exchangers were examined periodically after the salt spray test. One heat exchanger is cleaned periodically to remove the deposit. The thermal performances are evaluated both before and after cleaning. The other heat exchanger is evaluated without cleaning and removal of the deposits. The uncleaned heat exchanger shows much worse performance than the cleaned heat exchanger: a significant increase in the airside pressure drop and weight, also a decrease of the heat transfer coefficient have been identified. Our experimental results show a linear trend of thermal performance degradation vs. corrosion testing time. Data also suggests that the periodical cleaning of the heat exchanger may further accelerate the corrosion, indicated by the faster decrease of thermal performance and drop of HX weight.

1. INTRODUCTION

The aluminum heat exchangers may be subject to both external and internal (refrigerant side) corrosion under various environmental conditions. The corrosion potentially undermines the heat exchanger's mechanical integrity and thermal performance. For example, when using different fin and tube materials on one heat exchanger, the electrochemical corrosion will cause severe defects on more active components hence promote the decrease in performance (Zhao *et al.*, 2012). Even a coated heat exchanger can still be affected by corrosion. Corrosion can quickly attack the base metal if a defect exists on the coating (Fedrizzi *et al.*, 2008). The laboratory accelerated corrosion tests are commonly used to evaluate the corrosion resistance of aluminum heat exchangers to the external working environment. The accelerated corrosion tests may reasonably reproduce the real-life corrosion patterns of the heat exchangers in a relatively short period. Among various accelerated corrosion tests, it is reported that ASTM G85-11 Standard Practice for Modified Salt Spray (Fog) Testing Annex 3 (SWAAT) can reasonably mimic the corrosion patterns on the aluminum surface (Scott *et al.*, 1991). However, far less is known about the ways, and effects corrosion degrades the thermal performance of an aluminum heat exchanger.

The objective of this paper is to present the impact of the external corrosion generated by SWAAT tests on the thermal performance of the aluminum heat exchangers. It is known that after the exposure of heat exchanges to the salt spray

during the tests, a large amount of salt and corrosion products accumulate onto the heat exchanger surface. Such a heavy deposition does not usually occur to a heat exchanger in an actual working environment, even other forms of fouling occur (dust, lint, road salt, etc.). Therefore, when evaluating the effects of corrosion on the heat exchanger performance change due to the artificial surface deposition may not be practically important.

In this paper, two identical brazed aluminum heat exchangers went through a series of SWAAT and then thermal performance tests. The airside pressure drop, the heat exchanger UA value, and the weight of the heat exchangers are examined periodically during ten days of the salt spray test. One heat exchanger is cleaned before each hydraulic and thermal performance evaluation to remove the external surface deposition. The other heat exchanger is tested with the continuous accumulation of deposits. Such a comparative study provides information on the impact of heat exchanger performance due to: (1) actual corrosion on heat exchanger surfaces; (2) salt deposition generated during accelerated lab testing.

2. EXPERIMENTAL EVALUATION OF THE HEAT EXCHANGER PERFORMANCE

2.1 Heat Exchanger Corrosion Test and Cleaning Procedures

2.1.1 Corrosion test facility

The salt spray test follows the ASTM G85 Annex 3 (ASTM G85-11, 2011). An automatically controlled salt spray environmental chamber is used to conduct the test. The environmental chamber is where the heat exchanger samples are exposed to salt spray and fog. A nozzle is placed in the environmental chamber to atomize the salt solution, i.e., to provide the salt spray. The system is automatically controlled to maintain the proper test conditions. The temperature inside of the environmental chamber is maintained within 49 ± 2 °C. The relative humidity in the environmental chamber is kept above 98%.

2.1.2 Heat exchanger sample preparation

The aluminum heat exchanger samples are prepared from an unused automobile heat exchanger. The HX is cut in the middle to form two identical parts, sample A and sample B, as illustrated in figure.1. The dimensions for both samples are 228 mm in width, 228 mm in height, and 51 mm in depth. The current study is focused on changes in thermal performance due to corrosion on the major heat transfer surfaces. Therefore, the HX inlet and outlet tube and serpentine tube U-bends are protected by anti-corrosion tape to prevent possible fast tube perforation at these locations. The inlet and outlet of header tubes are sealed to prevent salt fog from entering the HX.

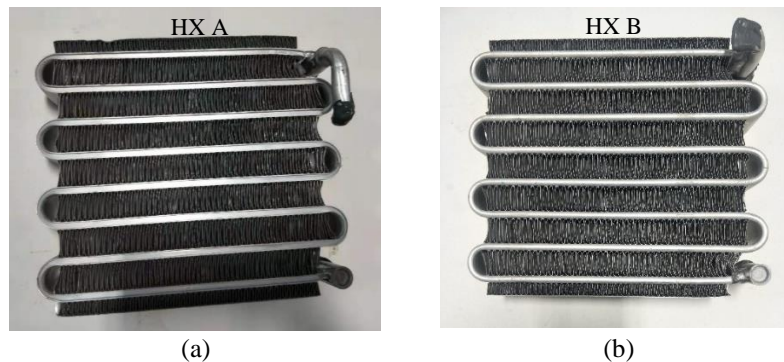

Figure 1: The samples: (a) HX A where degradation of the performance is evaluated with the continuously accumulated deposit; (b) HX B where every performance test was done after cleaning.

Both sample A and sample B went through 10 days of the SWAAT test in total. The samples are taken out of the environmental chamber for a thermal performance test in a wind tunnel facility after every two days of salt spray test. Sample A (HX A) and sample B (HX B) went through different cleaning procedures when removed from the environmental chamber. The cleaning procedures are described in the next section.

2.1.3 Sample cleaning procedures after salt spray test

For HX A, compressed air was gently blown to remove the loose deposit before it enters the wind tunnel facility. The purpose of this procedure is to test the HX thermal performance as is after the corrosion test, yet still prevent unnecessary contamination of the wind tunnel by the loose deposit on the heat exchanger. For HX B, the heat

exchanger was dipped into 5% nitric acid under room temperature after the corrosion tests. The purpose of this cleaning method is to eliminate the effect of deposit on the thermal performance test and the corrosion test that follows.

To evaluate the effectiveness of the cleaning, five aluminum coupons were exposed to the corrosion test and then cleaned with different methods. Each coupon has a dimension of around 7.5 cm in length and 2.5 cm in width. All five coupons went through the following testing procedures: the coupons are tested in the corrosion chamber for a total of 10 days, the corrosion test is paused every two days so that the coupons can be taken out for various cleaning procedures. After the salt spray test, the coupons are naturally dried, the weight of each aluminum coupon is then measured. During the cleaning process, coupons #1 and #2 are immersed in the 5% nitric acid solution at room temperature. To determine the proper immersion time, a test was performed after the 1st two-day corrosion test. After immersion for a selected duration, the coupons are taken out and naturally dried, weighted, then sent back to the immersion bath to repeat the exposure. The weights of aluminum coupons #1 and #2 vs. cleaning duration are shown in figure 2(a). Figure 2(a) indicates that a 2-minute acid washing time is sufficient to remove the deposit. The weights of aluminum coupons #1 and #2 during acid wash reduce fast in the first 30 seconds. A longer wash time than 120 seconds does not seem to affect the coupon weights anymore. Therefore, acid washing time is justified to be 2 minutes. Aluminum coupons #3 and #4 are cleaned by rinsing with water and gently brushed to remove the loosely attached deposit. Aluminum coupon #5 is cleaned only by gently blowing dry air. Figure 2(b) presents the weights of all five aluminum coupons before and after each cleaning. It is found that the acid wash leads to more weight loss than the water rinsing method, and coupon 5 shows little change in weight after the air blowing procedure.

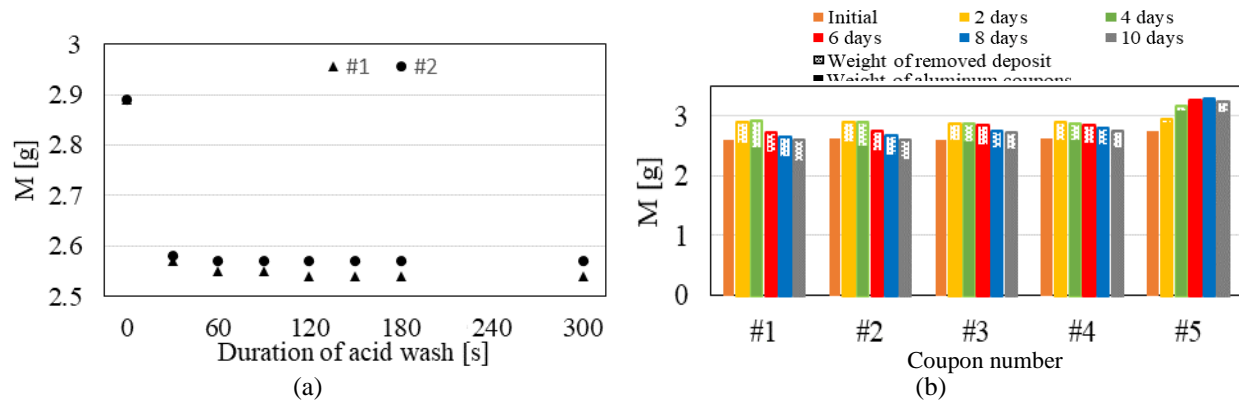

Figure 2: Weight change of aluminum coupons: (a) weight of coupons #1 and #2 (after the 1st two-day of corrosion test) as a function of acid washing time; (b) weight of coupons (#1 to #5) after every two days of corrosion test.

The appearances of aluminum coupons before and after the corrosion test (the 1st two-day corrosion test) and after cleaning are presented in figure 3(a), 3(b), and 3(c), respectively. Figure 3 shows that coupons (#1 and #2) after the acid wash are visually free of deposits, while the coupons (#3 and #4) after the water rinsing still have visible white deposits on the surfaces, and coupon 5 after air blowing is covered with heavy deposition. Therefore, the authors concluded that diluted acid wash is the most effective method among the three to remove the deposit on the aluminum surface.

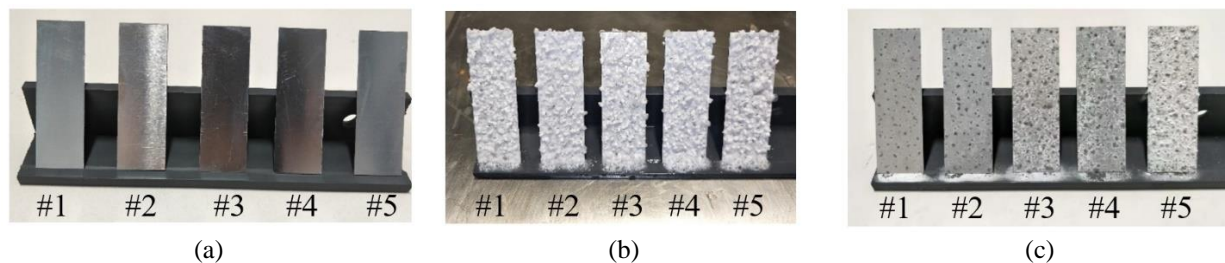

Figure 3: Appearance of aluminum coupons: (a) before salt spray test; (b) after two days of salt spray test; (c) after two days of salt spray test and cleaning procedure.

Based on the coupon test results, the cleaning procedures for heat exchanger samples after every two-day corrosion test are determined as follows: For HX A, it is first dried quiescently in the room, then cleaned by gently blowing compressed (dried) air. The objective of the air-blowing step is to avoid the loose deposit contaminate the wind tunnel in the following performance evaluation. This procedure only removes a small amount of deposit so that the impact of the salt spray deposition can be retained as much as possible. Also, a thorough clean with the 5% nitric acid solution is applied to the HX A after the ten-day salt spray test, to remove the deposit. The performance of the thoroughly cleaned heat exchanger A is also measured at the end of the ten-day test period to compare with the performance of the un-cleaned HX. For heat exchanger B, after every 2-day corrosion test, it is dried quiescently at room temperature and gently blew with compressed air. The heat exchanger performance is measured first as is. Then the heat exchanger is dipped in the 5% nitric acid at room temperature for 3 minutes to remove the deposit thoroughly. After the acid wash, HX B is rinsed with deionized water and dried quiescently at room temperature, and the HX performance is measured again. A slightly longer immersion time (3 minutes) is chosen to ensure the cleaning is complete as the heat exchanger has a more complex geometry than a coupon plate.

2.2 Evaluation of Heat Exchanger Performance

The heat exchanger performance is evaluated using a wind tunnel. The airside pressure drop was measured as the representation of the hydraulic performance, and the heat transferred was measured to acquire a product of overall heat transfer coefficient and heat transfer area UA as the representation of thermal performance. A schematic of the wind tunnel facility is illustrated in figure 4. The wind tunnel has an open-air loop and a closed water loop. The tests are performed at given air side flow rates (by controlling blower speed) and a heat load (by a heater in the water loop). The airside pressure differences across the heat exchanger are measured by a differential pressure transducer. The air pressure drop across the nozzles is also measured to calculate the airflow rate. The air temperatures at the heat exchanger inlet, outlet as well as at nozzle outlet are measured with T-type thermocouples. In the water loop, water is heated by an immersed heater, then pumped through the tube side of the heat exchanger. The water temperatures at the inlet and outlet of the heat exchanger headers are measured using type T thermocouples. The mass flow rate of the water is measured by a flowmeter.

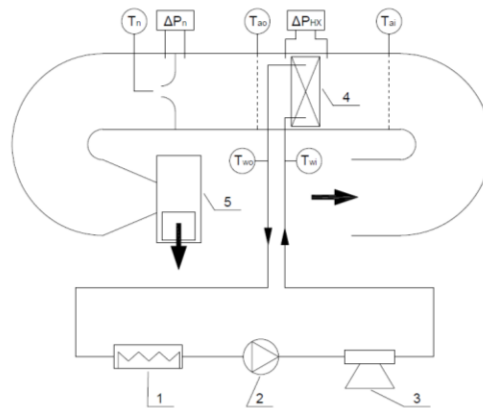

Figure 4: Schematics of the wind tunnel: 1 water heater; 2 water pump; 3 flow meter; 4 heat exchanger sample; 5 blower

The waterside heating capacity is kept at around 1000 W . The water flow rate is maintained at 115 g/s. Three air volumetric flow rates are applied, which are 0.103 (-0.001, +0.005) m^3/s , 0.138 (-0.002, +0.006) m^3/s , and 0.170 (-0.002, +0.007) m^3/s . The airflow rate is calculated based on the temperature and pressure measurements at the nozzles referring to ASHRAE standard 41.2 (ASHRAE 41.2-18, 2018). The airside capacity \dot{Q}_a is calculated using the following equations.

$$\dot{M}_a = \rho_n \dot{V} \quad (1)$$

$$\dot{Q}_a = \dot{M}_a (h_{ao} - h_{ai}) \quad (2)$$

The water-side capacity \dot{Q}_w is calculated using the following equation.

$$\dot{Q}_w = \dot{M}_w (h_{wi} - h_{wo}) \quad (3)$$

All calculations and determination of property parameters are achieved by Engineering Equation Solver. The product of the overall heat transfer coefficient and heat transfer area UA is calculated with the following equations.

$$UA = \frac{1}{2} \frac{\dot{Q}_a + \dot{Q}_w}{LMTD} \tag{4}$$

Where LMTD is the log mean temperature difference calculated by Eq. (5).

$$LMTD = \frac{(T_{wo} - T_{ai}) - (T_{wi} - T_{ao})}{\ln\left(\frac{T_{wo} - T_{ai}}{T_{wi} - T_{ao}}\right)} \tag{5}$$

3. RESULTS AND DISCUSSION

3.1 Surface Appearance and Weight Change of The Heat Exchangers

Some general observations on the HX front surface appearance are presented in figure 5.

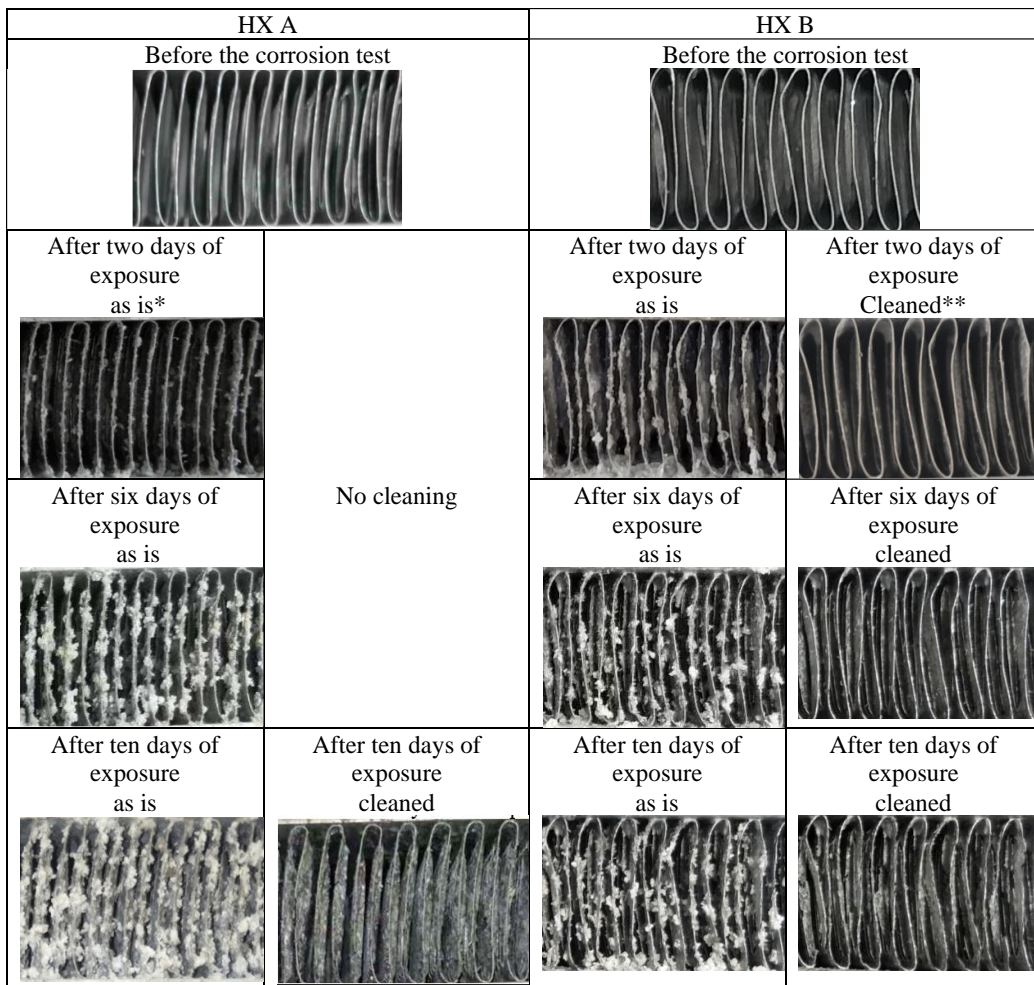

*The heat exchanger sample is dried naturally at room temperature then gently blown with compressed air to remove the loose deposit.

** The heat exchanger sample is dipped in 5% nitric acid, rinsed with deionized water, then dried naturally at room temperature. The deposit is removed thoroughly.

Figure 5: Appearance of the front side of two exchanger samples at various stages of the experiments.

The deposit on HX A accumulates in time. The accumulated deposit was removed only after a 10-day corrosion test is completed. HX B was cleaned following an acid washing procedure after every two days of the SWAAT test. In figure 5, the photos of cleaned HX B show that the defects on the fins appear and become more severe as the corrosion test time increases.

The weight of HX A increases continuously in time, as illustrated in figure 6(a), confirming continuous deposit accumulation. However, when HX A is thoroughly cleaned by the acid washing procedure after the ten-day corrosion test, we measured a 2.3% weight loss compared to the original HX weight. The slight weight reduction indicates that there is a material loss of the HX due to corrosion. The weight of the HX B before and after the cleaning is presented in figure 6(b) indicated by the solid and hollow squares, respectively. The weight after cleaning decreases continuously at a relatively constant rate throughout the ten days of the corrosion test.

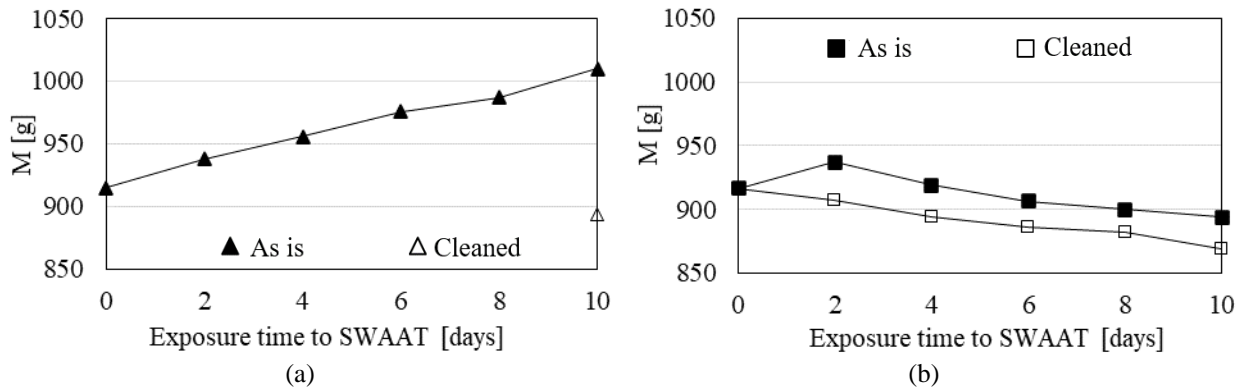

Figure 6: Weights of HXs during the experiments: (a) the weight of HX A continuously increases when the accumulation of deposit was uninterrupted (see the solid triangles); (b) the weight of HX B continuously decreases when thoroughly cleaned after every two days of corrosion test (see the hollow squares). The “as is” and “cleaned” conditions correspond to the definitions listed in figure 5

The weight changes of the cleaned HXs (hollow triangle in figure 6(a) and hollow squares in figure 6(b)) indicate that continuous accumulation of the deposit may slow down the corrosion of the heat exchanger. The weight of HX A, only cleaned after the ten-day corrosion test, is reduced by 2.3%, while the weight of HX B, which is cleaned after every two days of the test is reduced by 5.2% after the completion of the 10-day corrosion test. The greater weight loss of HX B indicates a higher corrosion rate on the cleaned surface. It appears that the deposit on the heat exchanger formed during the salt spray test may protect the surface, decelerating the corrosion by blocking the direct contact between the heat exchanger material and the salt fog.

3.2 Thermal and Hydraulic Performance of the HX A

As described in the test procedures, the thermal performance of the HX A is evaluated after every two days of the corrosion test at an as-is dry condition. A nitric acid solution (5%) cleaning procedure is only applied after the completion of overall ten-day testing to thoroughly remove the deposits on the HX surface accumulated over the entire corrosion test duration. The thermal performance of the heat exchanger is characterized by air side pressure drop and overall UA value at the given airflow rate and cooling capacity. The performance evaluation results at the nominal airflow rate of $0.17 \text{ m}^3/\text{s}$ are presented in this paper as a representation. Figure 7(a) shows the air side pressure drop vs. corrosion test duration; figure 7(b) shows the UA vs. corrosion test duration. The solid points correspond to the HX performance before the acid wash, i.e., the deposit from the corrosion tests is mostly unchanged. The hollow point on the 10th day corresponds to the HX performance after the acid wash, i.e., after the deposit is removed.

The airside pressure drop of HX A increases linearly in time, as shown in figure 7(a). A linear trend of HX weight increase and corrosion test duration has been previously presented in 3.1, figure 6(a). Visual inspection of the heat exchanger surface (see figure 5: ten-day corrosion test and as-is condition) shows that the accumulated deposit on the heat exchanger surface may have partially blocked the air pass area. Therefore, it is reasonable to believe that the deposit formed during the salt spray test is the dominant cause of the increase of the HX A airside pressure drop when they are not removed from the heat exchanger. When the deposit is not removed, the pressure drop of HX A increased 97% after ten days of the salt spray test. After cleaning, the pressure drop shows an increase of 12% over the initial

value (hollow triangle in figure 7(a)). The relatively small pressure drop increase after the removal of the deposit may be correlated to the fin/tube surface damages caused by the corrosion.

The heat transfer performance of the HX A (represented by the UA value), presented in figure 7(b) shows a continuous decrease in time without cleaning. When the deposit remains on the HX surface, the change of thermal performance is affected by both the deposit (e.g. increased thermal resistance) and the damage due to corrosion. After the ten-day corrosion test, when the deposit is removed from the HX surface, the UA value (the hollow triangle in figure 7(b)) shows a 10% decrease compared to the original HX performance, but a 2.3% increase compared to the HX performance before the deposit was removed. In this case, i.e., when the deposit is removed, the impact due to the surface deposition has been largely eliminated. Therefore, after ten days of corrosion test and cleaning, the 10% decrease in heat transfer performance and the 12% increase in pressure drop compared to the initial value more closely reflect performance degradation due to the damage of the HX surface caused by corrosion.

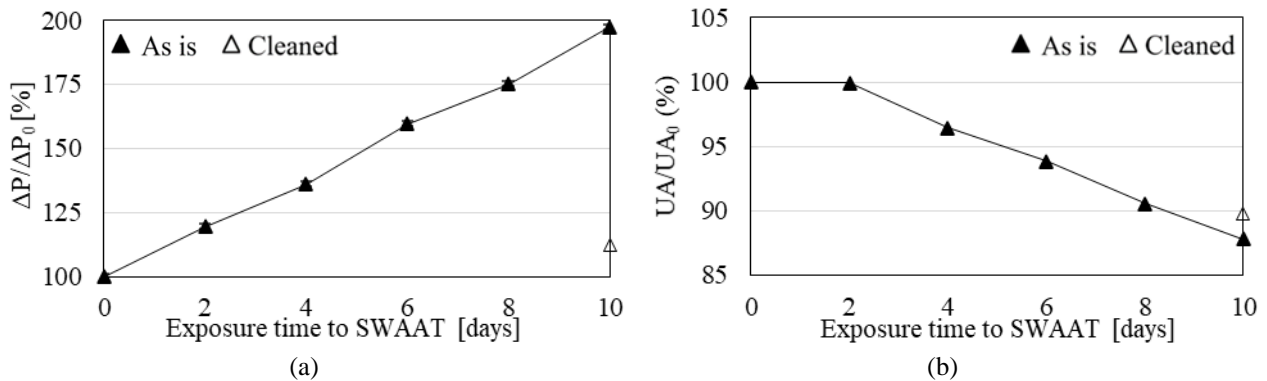

Figure 7: The performance of HX A (continuously accumulated deposit in time): (a) airside pressure drop increases continuously in time, except when the deposit is removed after the ten-day test; (b) UA value decreases as the corrosion test duration increases.

3.3 Thermal and Hydraulic Performance of the HX B

For the HX B, which is thoroughly cleaned with the acid wash after every two days of the corrosion test, the change of pressure drop is less significant than the changes measured in the HX A. The measured pressure drop and UA results are presented in figure 8. Figure 8(a) shows that at the given airflow rate, the pressure drop of the cleaned HX B presents very little variation, regardless of the duration of the corrosion tests. The increase of the pressure drop after every two-day corrosion test (without cleaning) over the original pressure drop is in a range between 14.9% and 22.9%. These test results indicate that the deposit on the HX surface is the main cause of the increase of airside pressure drop, which is consistent with the conclusion based on the HX A testing results.

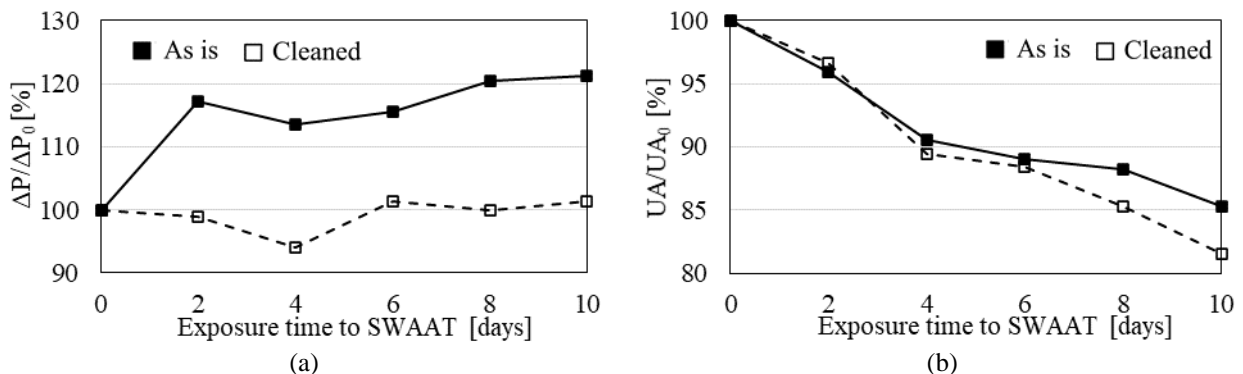

Figure 8: The performance of HX B (thoroughly cleaned after each two-day corrosion test session): (a) the airside pressure drop of the uncleaned HX B is higher than the cleaned HX B; (b) UA values decrease when the corrosion test duration increases, for both uncleaned and cleaned HXB.

Figure 8(b) shows the UA of HX B vs. corrosion test duration, both before and after the surface cleaning procedure. In general, the UA value of HX B decreases as the corrosion test duration increases. It is interesting to see that the difference between the UAs before and after the cleaning procedure is relatively small, especially for corrosion test durations shorter than six days. After eight days of corrosion test duration, the UA value of the cleaned HX tends to be smaller than the UA value before the cleaning procedure. There are two opposite effects of the surface deposition on the heat transfer performance: (1) the deposit serves as a heat transfer barrier of the metal fins and tubes, therefore, reduces the overall heat transfer coefficient; (2) the accumulation of the deposit also leads to a reduction in the opening between the fins, and thus the increase air velocity at the given airflow rate, so the heat transfer coefficient may be increased. The overall reduction of UA value (the solid squares in figure 8(b)) is the result of both effects. When the deposit is removed from the HX surface, the reduction of the UA value (the hollow squares in figure 8(b)) is dominantly controlled by the level of surface damage, which is more realistically reflecting the heat exchanger performance degradation due to corrosion. Compare figure 7(b) and figure 8(b), it is found that the reduction in UA of HX B is more rapid than that of HX A. After the ten days of the corrosion test and the removal of the deposit, the UA of HX A reduced to 90% of its initial value, while the UA of HX B reduced to 81% of the initial value. This indicates that the heavier deposition on HX A may have mitigated the corrosion on the heat exchanger surface, thus reduced the deterioration of the UA on HX A. In other words, the deposit on the HX surface can slow down the salt spray corrosion and potentially make the corrosion test less efficient.

3.4 Impact of The Corrosion and Deposit on Heat Exchanger Performance

According to the previous discussion, it can be seen that the thermal performances of aluminum heat exchangers are significantly different if treated with different post-corrosion cleaning procedures. In addition to the corrosion attack, the surface deposit from the corrosion tests plays important role in the heat exchanger performance. Figure 9 shows the “as is” pressure drop of the HX A (relative to its initial pressure drop before the corrosion tests) with a continuously accumulated deposit versus the increased weight of the heat exchanger. A linear correlation was confirmed between the two parameters. Such a linear correlation indicates that the accumulated deposit on the heat exchange surface after the SWAAT test, if not removed, is the dominant cause of the significant increase of the airside pressure during performance evaluation.

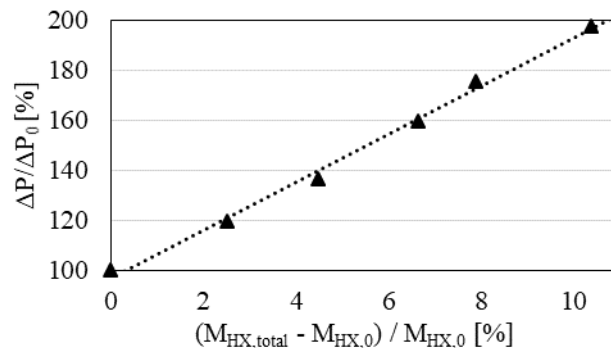

Figure 9: A linear correlation between the relative airside pressure drop and the relative weight change of HX A during the ten-day corrosion test

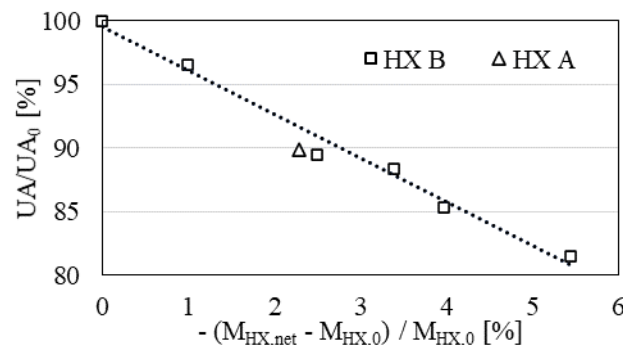

Figure 10: A linear correlation between the decreasing relative UA and the increasing weight loss of cleaned HX A and cleaned HX B during and after ten days of salt spray test

From the results of the performance evaluation of HX B, it is also found that the change of UA value is closely related to the weight loss of the cleaned heat exchanger over the original HX weight. Figure 10 shows the change of UA of the cleaned HX B versus the weight loss of the cleaned HX B throughout the salt spray test. It can be observed that the UA decreases linearly as the weight loss increases. This relation between the UA and weight loss may be explained as follows: The weight loss caused by corrosion indicates the loss of heat transfer area, e.g., fin damages, fin/tube debonding, and subsequently leads to the reduction of heat transfer capability. Therefore, the UA value of a corroded heat exchanger may be reasonably correlated to its weight change due to the corrosion attack, when a proper cleaning procedure is performed after the corrosion test. However, a more in-depth study is needed to verify such speculations and will be performed in future work.

3.5 Uncertainty Analysis

The accuracy of the measuring instruments used in the evaluation of heat exchanger performance is shown in table 1.

Table 1: Accuracy of instruments

Measurement	Instrument	Accuracy
T_a, T_w	T type thermocouple	± 0.1 °C
\dot{M}_w	Micro Motion CMF025 Coriolis flow and density meter	$\pm 0.1\%$ of the measured value
ΔP_{HX}	Rosemont 1151 pressure transmitter	± 1.556 Pa
ΔP_n	Rosemont 1151 pressure transmitter	± 1.245 Pa

The RSS uncertainties at 95% confidence level of the airside pressure drop and UA are calculated using the propagation of the uncertainty, referring to Dieck (2007). Before using the propagation of the uncertainty, the standard elemental uncertainty of each measured variable x_k is the yield from combining the systematic uncertainty b_i and the random uncertainty s_k , where the subscript k denotes the k^{th} variable. The RSS accuracy is calculated using the following equation. Where F is the variable which is calculated using the measured variables x_k . The calculated uncertainties of the experiment results are shown in Table 2.

$$U_{95} = 2 \sqrt{\sum_{k=1}^N (s_k \frac{\partial F}{\partial x_k})^2 + \sum_{k=1}^N (b_k \frac{\partial F}{\partial x_k})^2} \quad (6)$$

Table 2: Uncertainty of airside pressure drop and UA

Sample	Condition	Variables	Units	Duration of salt spray test					
				0 day	2 days	4 days	6 days	8 days	10 days
HX#A	with deposit	$U_{UA,95}$	%	\	3.98	4.50	4.18	5.43	4.22
		$U_{\Delta P,95}$	%	\	1.07	0.92	0.78	0.68	0.70
HX#A	without deposit	$U_{UA,95}$	%	4.84	\	\	\	\	4.26
		$U_{\Delta P,95}$	%	1.94	\	\	\	\	1.15
HX#B	with deposit	$U_{UA,95}$	%	\	7.77	7.84	6.68	6.87	6.97
		$U_{\Delta P,95}$	%	\	2.38	2.03	1.65	1.88	1.90
HX#B	without deposit	$U_{UA,95}$	%	9.76	7.70	8.53	7.93	7.21	7.78
		$U_{\Delta P,95}$	%	2.34	3.04	2.51	2.36	2.30	2.18

4. CONCLUSIONS

In this study, we have illustrated that the deposit formed in a salt spray test can significantly affect the performance of HXs. For the hydraulic performance, the airside pressure drop is significantly increased by the accumulated deposit

in the SWAAT, as shown by comparing the airside pressure drop of cleaned and uncleaned HXs in figure 7(a) and figure 8(a). For the thermal performance, the decreasing UA is the result of both corrosion and deposit formed during the SWAAT, as discussed in sections 3.2 and 3.3. It is found that the decrease of UA on a cleaned HX is closely related to the corrosion effect, as discussed in section 3.4 and illustrated in figure 10. The continuous deposition caused by salt spray may serve as a coating barrier and decelerate the corrosion on heat exchanger surfaces. This is indicated by the less mass loss (figure 6(a)) and less decrease in UA (figure 7(b)) on HX A after ten days of SWAAT, comparing with HX B (figure 6(b) and figure 8(b)). It is essential to remove the deposit before the performance evaluation to yield a reliable result to better represent the actual performance in field service. We have demonstrated that the applied cleaning procedure is effective in removing the deposit on tested aluminum heat exchangers after SWAAT.

NOMENCLATURE

			Subscript	
\dot{Q}	Heat transfer rate	(W)		
\dot{M}	Mass flow rate	(kg·s ⁻¹)		
ρ	Density	(kg·m ⁻³)	a	Air
\dot{V}	Volumetric flow rate	(m ³ ·s ⁻¹)	n	Nozzle
h	Enthalpy	(J·kg ⁻¹ ·K ⁻¹)	o	Outlet
UA	Product of overall heat transfer coefficient and heat transfer area	(W·K ⁻¹)	i	Inlet
			w	Water
LMTD	Log mean temperature difference	(°C)	0	Initial
T	Temperature	(°C)	HX	Heat Exchanger
M	Mass	(kg)		
U	Relative uncertainty	(%)		
s	Relative standard random uncertainty	(%)		
F	The function of the target variables	(-)		
x	Component of the target variables	(-)		
b	Relative systematic uncertainty	(%)		
N	Number of the component	(-)		

ACKNOWLEDGMENT

The authors would like to thank the member companies of the Air Conditioning & Refrigeration Center at the University of Illinois at Urbana-Champaign for their financial support, as well as Creative Thermal Solutions, Inc. (CTS) for providing testing facilities, and CTS employees for their technical support.

REFERENCES

- American Society for Testing and Materials. (2011). *Standard Practice for Modified Salt Spray (Fog) Testing*. <https://doi.org/10.1520/G0085-11>
- American Society of Heating, Refrigerating and Air-Conditioning Engineers. (2018). *Standard Methods for Air Velocity and Airflow Measurement*.
- Dieck, R.H. (2007). *Measurement uncertainty: Methods and applications*. ISA, NC.
- Fedrizzi, L., Andreatta, F., Paussa, L., Deflorian, F., & Maschio, S. (2008). Heat exchangers corrosion protection by using organic coatings. *Progress in Organic Coatings*, 63(3), 299–306. <https://doi-org.proxy2.library.illinois.edu/10.1016/j.porgcoat.2008.01.009>
- Scott, A., Woods, R., & Harris, J. (1991). Accelerated corrosion test methods for evaluating external corrosion resistance of vacuum brazed aluminum heat exchangers. *SAE Transactions*, 100, 578–586.
- Zhao, Y., Qi, Z., Wang, Q., Chen, J., & Shen, J. (2012). Effect of corrosion on performance of fin-and-tube heat exchangers with different fin materials. *Experimental Thermal and Fluid Science*, 37, 98–103. <https://doi.org/10.1016/j.expthermflusci.2011.10.008>