

2004

# Analytical and Experimental Study on a Scroll Compressor

Hamdy A. Gouda Mahfouz  
*Universiti Teknologi Malaysia*

Mat Nawi Bin Wan Hassan  
*Universiti Teknologi Malaysia*

Mid Nor Musa  
*Universiti Teknologi Malaysia*

Follow this and additional works at: <https://docs.lib.purdue.edu/icec>

---

Mahfouz, Hamdy A. Gouda; Hassan, Mat Nawi Bin Wan; and Musa, Mid Nor, "Analytical and Experimental Study on a Scroll Compressor" (2004). *International Compressor Engineering Conference*. Paper 1648.  
<https://docs.lib.purdue.edu/icec/1648>

This document has been made available through Purdue e-Pubs, a service of the Purdue University Libraries. Please contact [epubs@purdue.edu](mailto:epubs@purdue.edu) for additional information.

Complete proceedings may be acquired in print and on CD-ROM directly from the Ray W. Herrick Laboratories at <https://engineering.purdue.edu/Herrick/Events/orderlit.html>

# Analytical and Experimental Study On A Scroll Compressor

Hamdy.A.Gouda Mahfouz<sup>1</sup>, Mat Nawi Bin Wan Hassan<sup>2</sup>, Md Nor Musa<sup>3</sup>

<sup>1</sup> Universiti Teknologi Malaysia (UTM), Faculty of Mechanical Engineering,  
Johor, Malaysia

Contact Information (Tel 607-5534769, Fax 607-5566159, E-mail- [mahfouze@hotmail.com](mailto:mahfouze@hotmail.com))

<sup>2</sup> Universiti Teknologi Malaysia (UTM), Faculty of Mechanical Engineering,  
Johor, Malaysia

Contact Information (Tel 607-5534755, Fax 607-5566159, E-mail- [matnawi@fkm.utm.my](mailto:matnawi@fkm.utm.my))

<sup>3</sup> Universiti Teknologi Malaysia (UTM), Faculty of Mechanical Engineering,  
Johor, Malaysia

Contact Information (Tel 607-5534567, Fax 607-5566159, E-mail- [mdnor@fkm.utm.my](mailto:mdnor@fkm.utm.my))

## ABSTRACT

The demand for the compressor for the HVAC application is always on the increase particularly for the compressor of the scroll type. The popularity and high demand for the scroll compressor are due to the technological development that makes the compressor more efficient and attractive.

This paper discusses the analytical and the experimental determinations of the p-v diagram and mass flow rate for the scroll compressor on the scroll compressor. The experimental evaluation for the pressure volume diagram was made using four piezo-electric transducers at selected positions to obtain the pressure –crank angle with the help of data acquisition and software.

An analytical model was also developed. The model takes into account the leakage at the flank and at the tip of the scroll compressor. The simulation studies were carried out under different leakage clearances. The paper further discusses the heat transfer loss, and the thermal contact loss between the fixed and the orbit scrolls. The analysis includes the conduction heat transfer through the bases of the orbit and the fixed scroll, and the convection heat transfer between the refrigerant and the scroll walls in the suction port. The experimental and computed results were compared at different working conditions and found to be in a good agreement.

## 1. INTRODUCTION

Thermodynamic analysis on a small compressor is important in evaluation of the thermal characteristics of small compressors besides the dynamic characteristics such as vibration, noise and friction. The thermodynamic analysis takes account of pressure inside the compressor, heat transfer, leakage, mass flow rate of the gas in the compressor and the power consumed. The working principle of a scroll compressor has been discussed by (L.Creux, 1905), but the compressor was not fully manufactured until the mid of 1970s. Many researchers have presented the thermodynamic analysis, for instance (Y Chen, Nils. H., E.A. Groll, and J E Braun, 2000) presented a detailed analytical model for the scroll compressor. The pressure measurements inside the compressor were presented by (Raymond, and Richard, 1988). This paper presents a comparison between an experimental and analytical studies on the p-v diagram, and the mass flow rate of a small compressor used for automobile application. The pressure was measured using four piezo-electric transducers at different positions.

## 2 ANALYTICAL MODEL

To determine the pressure, volume, mass flow rate and power for the compressor, the geometry, the leakage and heat transfer must first be determined.

## 2.1 Scroll Geometry

The geometry of the selected compressor used in our study was first investigated. It was found that the curvature for the involute could be evaluated by the following equations as described by (S. Sunder, 1997):

$$X = a(\cos f + f \sin f)$$

$$Y = a(\sin f - f \cos f)$$

The scroll inner end geometry for that commercial compressor does not follow the above equations. It was found that the inner end geometry could be determined by a modified end method as described by (L. Zhenquan, D. Guirong, Y. Shicai, and W. Mingzhi, 1992), also the wrap used a cut out or relief at a very inner portion of the involute to avoid the hydraulic lock as described by (J. W. Bush, and A. Lifson, 1998). The nearest dimension was established by trial and error. Fig.1 shows the relieved portion of the scroll wrap. The estimated specification of the scroll and the inner end for the scroll wrap is given as follows; The basic circle radius “a” = 3.2054 mm, Thickness of wrap = 4.58 mm, Height of the scroll = 33.25 mm, and the end specification are small radius “r” = 3.7001mm, big radius “R” = 9.1908 mm,  $\gamma = 65^\circ$ ,  $\beta = 14.91018^\circ$ . Using the above geometry specifications the volumes of suction, compression and discharge were calculated

## 2.2 Thermodynamic properties P & T

In this study the analytical solution was determined by assuming the working fluid as a perfect gas and the properties of the fluid in the control volume, suction, compression and discharge are uniform throughout their respective volume at any instant of time. Any change in the properties of the gas in the individual volumes is instantaneously propagated throughout that volume. The suction can be divided into two stages as in (L.Huiqing, W. Disheng, and C.Penggao, 1992). Using a fourth order Runge Kutta method, the pressure and temperature distributions inside the closed chamber were determined using the differential form of the equations of state as follows:

$$\frac{dp}{dt} = \frac{g}{V} \left( -P \frac{dV}{dt} + \sum T_{in} R \frac{dm_{in}}{dt} - T_{out} R \frac{dm_{out}}{dt} \right) \quad (1)$$

$$\frac{dT}{dt} = \frac{T}{V} \frac{dV}{dt} + \frac{T}{p} \frac{dp}{dt} - \frac{T}{m} \frac{dm}{dt} \quad (2)$$

where, the instantaneous mass flow rate,  $\dot{m}$ , for the discharge gas entering or leaving the control volume was determined by the following equation.

$$\dot{m} = A_{low} p_u \sqrt{\frac{2g_c}{(g-1)RT_{up}}} \sqrt{\left(\frac{p_{low}}{p_{up}}\right)^{\frac{2}{g}} - \left(\frac{p_{low}}{p_{up}}\right)^{\frac{g+1}{g}}} \quad (3)$$

The above equation is valid for un-choked flow.

For the critical flow,  $\frac{p_{critical}}{p_{up}} = \left(\frac{2}{g-1}\right)^{\frac{g}{g-1}} = r_c$ , where “ $r_c$ ” is the critical pressure ratio.

The mass flow rate under the choked condition is

$$\dot{m}_{critical} = A p_u \sqrt{\frac{2g_c}{(g-1)RT_{up}}} \sqrt{\left(r_c\right)^{\frac{2}{g}} - \left(r_c\right)^{\frac{g+1}{g}}}$$

where, A is the discharge opening area and can be evaluated from the geometry of the scroll.

## 2-3- Leakage and Heat Transfer

The scroll compressor has two types of leakage in which the fluid flows from higher-pressure chamber to a lower-pressure chamber. Gas from one of the leakages flows through the axial clearance between the orbiting scroll end plate and a fixed scroll. The other is the leakage through the radial clearance between the height of the orbit and the fixed scrolls. The pressure difference between the high-pressure chamber and the low-pressure chamber causes the leaked gas to flow through the axial and radial clearances. The model used in this study assumed that the fluid is viscous and incompressible as in (N.Ishii, K.Bird, K Sano, M Oono, S Iwamura and T Otokura ,1996) the pressure difference for radial leakage is determined by

$$\frac{p - p_a}{r g} = \mathbf{I} \frac{L}{4 m 2g} u_m^2,$$

and for axial leakage is by

$$\frac{p - p_a}{r g} = \int_{-f}^f \mathbf{I} \frac{R d\mathbf{f}}{4 m 2g} u_m^2$$

The lumped heat transfer model was used to evaluate the amount of heat gained in suction process from the discharge. There are three modes of heat transfer gained from the discharge. The first one is conduction through the metal of the fixed and orbit scrolls from discharge to suction. The next is the transient conduction through the fixed and orbit scrolls “kissing heat transfer” (S. Sunder, 1997). The last one is convection between the gas and wall at the suction. The conduction through the metal of the fixed and orbit scrolls bases were simply as radial conduction.

The convection coefficient “h” can be evaluated as follows:  $h = \frac{Nu.K_g}{D_h}$  where,

$Nu = .023 Re^{0.8} Pr^{1/3}$ ,  $K_g$  = gas thermal conductivity,  $D_h$  = hydraulic diameter. The channel width is the orbit radius and its height is the scroll height.

## 3. EXPERIMENTAL EQUIPMENT

### 3.1 Test Facilities

A schematic diagram of the main apparatus employed is shown in Fig. 2. Basically the system consists of an air conditioner for a passenger car components (condenser, compressor, expansion valve, filter drier and evaporator). The refrigerant pressure and temperature were measured at four different locations as defined in the diagram. The refrigerant temperatures were measured using K-type thermocouples and the compressor speeds were measured using the encoder installed on the compressor. The encoder was also used to determine the start and end of the cycle. The mass flow rate was measured using the flow meter and by a heat balance inside the calorimeter.

In order to measure pressures in the compression pockets, four piezoelectric pressure sensors were mounted in the fixed scroll. The reference pressure was determined when the two pressure transducers measured the common pressure in a chamber.

### 3.2 Data Acquisition

DAQ system consists of transducers, signal condition or signal amplifier, DAQ hardware, and software. The pressure signals can be measured by using the piezoelectric pressure transducer, which acts on the diaphragm, and converts the pressure into a proportional force. This force is transmitted onto the quartz, which under loading condition will yield an electrostatic charge. An electrode pick up this negative charge and pass it to a plug, after which the connected charge amplifier converts and optimized it into (positive) voltage. The signal then transmitted into the DAQ hardware. The data acquisition hardware comes in many physical formats, a common type is the plug in card, which fits into a free expansion slot in the computer. Basic specification of the DAQ card tells us the number of channels, sampling rate, resolution and input range. Four-pressure transducers located in the fixed scroll

as shown in Fig.3 . Each transducer can measure a certain portion of the compression cycle as described from Fig.4. The installation of the pressure transducer by the mounting sleeve is shown in Fig.5 and typical measurements of the end coder signal and the dynamic pressure for the four transducers are shown in Fig.6. The pressure sensors measure the dynamic signals and it could be converted to the absolute pressure. The pressure from the transducer number 1 refers its reference pressure from the suction pressure, which is measured from the pressure gauge. The pressure transducer number 2 uses reference pressure from pressure transducer number 1. This reference pressure is taken when pressure transducer number 1 and number 2 are measuring the same common pressure. Pressure transducer number 3 uses the reference point from pressure transducer number 2 and is taken when the two transducers are measuring the same cavity. Similarly for transducer number 4 uses transducer number 3. Fig.6 shows the results of the dynamic pressure from the four pressure transducers. Fig.7 shows the absolute pressure after converting the dynamic pressure of Fig. 6.

#### 4- RESULTS AND DISCUSSION

The volume of suction, compression and discharge were evaluated and plotted in Fig.8. A representative pressure crank angle relationship generated from experimental measurement is shown in Fig.9 The Figure also compares the predicted pressure obtained from the computer simulation and experimental for the scroll compressor. The comparison of the calculated and the experimental mass flow rate is presented in Fig.10. Unfortunately, the transducer number 4 did not cover the full 360 degree of the discharge because of the geometry constrains. It can be observed in the same Figure that there is a good agreement between the predicted and measured pressure dynamics in the region of measurements with axial and radial clearances of 4 and 8 *mm* respectively. It can also be seen from the Figure that the pressure at 345 degree to 360 degree goes up and then decreases. Our explanation to this phenomenon is that in our geometric investigation at the end of the compression process, the compression pocket opened to a small portion of the discharge port. At that time the gas from the discharge port flows rapidly into the compression pocket. Simultaneously the reed valve tries to go back to its seat to close the port opening. When this happened, the compression pocket and discharge pocket merged together and the pocket pressure decreased, after that the gas compressed again until it is high enough to overcome the discharge pressure and the stiffness of the reed valve.

Fig.11 shows the axial and radial leakages from the compression to suction with clearances of 4, and 8 *mm* respectively. The results of calculation are for one compression pocket. It is clear from the graph that the effect of the axial leakage rate is significantly higher than the radial leakage in spite of the leakage clearance in the axial being less than the radial clearance. This is because the leaking path length of axial leakage is much higher than radial leakage. Fig.12 shows the leakage rate from the discharge to compression pockets with axial and radial leakage of 4 and 8 *mm* respectively. Fig.13 shows the resultant leakage flow rate into and out of the compression pocket

Fig.14 shows the p-v at 1530 and 2020 rpm with the same suction and discharge pressures. The curve of the higher speed is lower than that of the lower speed.

#### 6-CONCLUSION

This paper presented scroll geometry and evaluated geometry of a commercial scroll compressor using available models and found that they are in a good agreement after comparing it with the scanned involute.

The p-v diagram from the experimental and analytical methods were obtained and compared. The results are also in a good agreement. The use of the analytical model can be justified to predict the actual performance of compressor.

#### REFERENCES

L.Creux, 1905, "Rotary Engine", *US Patent* No. 801182

Yu Chen, Nils H., E.A. Groll, J E Braun, 2000 "A Comprehensive Mode; Of Scroll Compressors " *International Engineering Conference at Purdue*

Raymond, Richard, 1988 "Instrumentation And Data Analysis Techniques For Scroll Compressor " *International Engineering Conference at Purdue*

Sankar Sunder, 1997 “Thermodynamic and Heat transfer Modeling of a scroll pump” *PhD thesis, Massachusetts Institute Of Technology*

Liu Zhenquan, Du Guirong, Yu Shicai, Wang Mingzhi , 1992 “The Graphic Method Of ModifiedWrap Of Scroll Compressor” *International Engineering Conference at Purdue*

James W Bush ,A. Lifson, 1998 “Controlling Discharge Valve Closing Impact In Scroll Machines” *International Engineering Conference at Purdue*

LiHuiqing,Wang Disheng,Chen Penggao ,1992 “Research Of Oil-Injected Scroll Compressor Working Process ” *International Engineering Conference at Purdue*

N.Ishii, K.Bird,K Sano,M Oono, S Iwamura and T Otokura,1996 “Refrigerant Leakage Flow Evaluation For Scroll Compressors” *International Engineering Conference at Purdue*

### ACKNOWLEDGEMENT

The authors would like to express their sincere thanks to the Malaysia Ministry Of Science Teknologi And Innovation for their funding, and also Universiti Teknologi Malaysia Research Management Center for managing the fund.

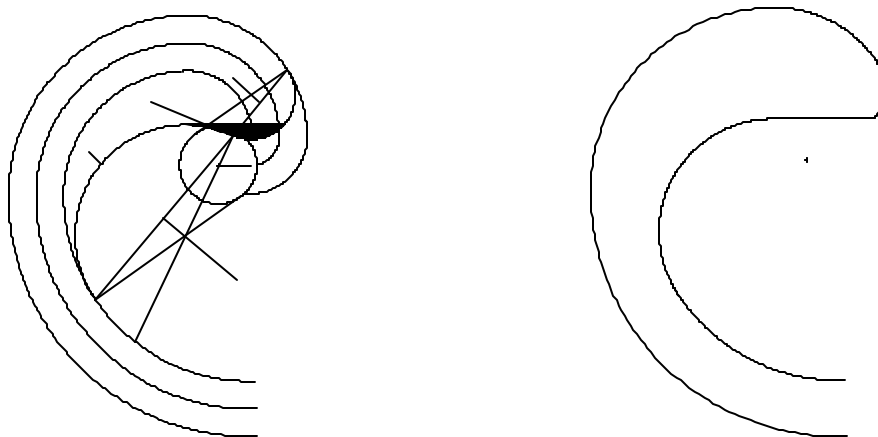

Fig.1 Evaluation of the wrap end

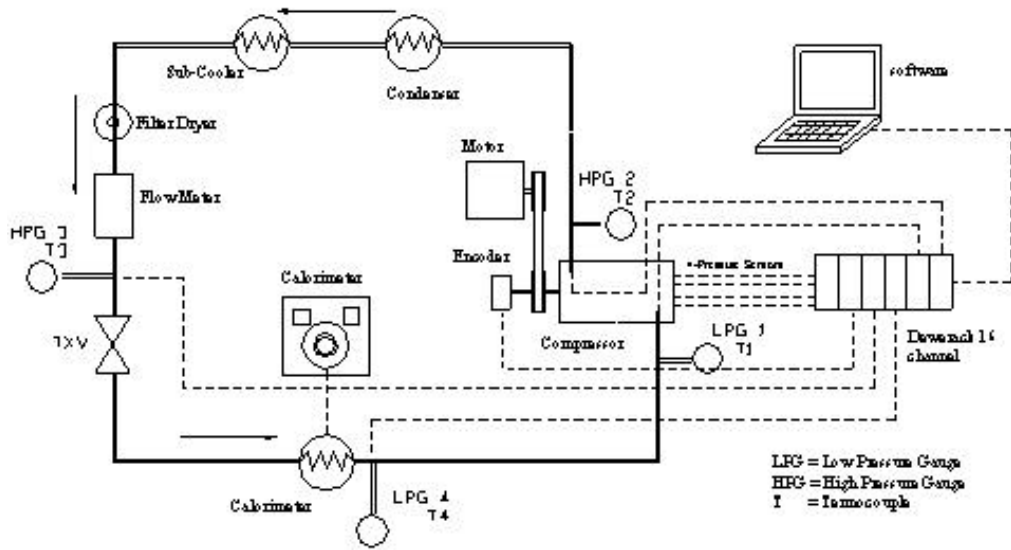

Fig. 2 Schematic diagram of the experiment

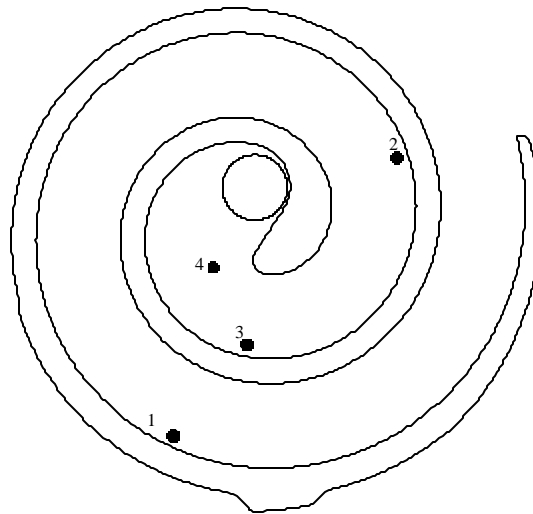

Fig.3 Position of the transducers

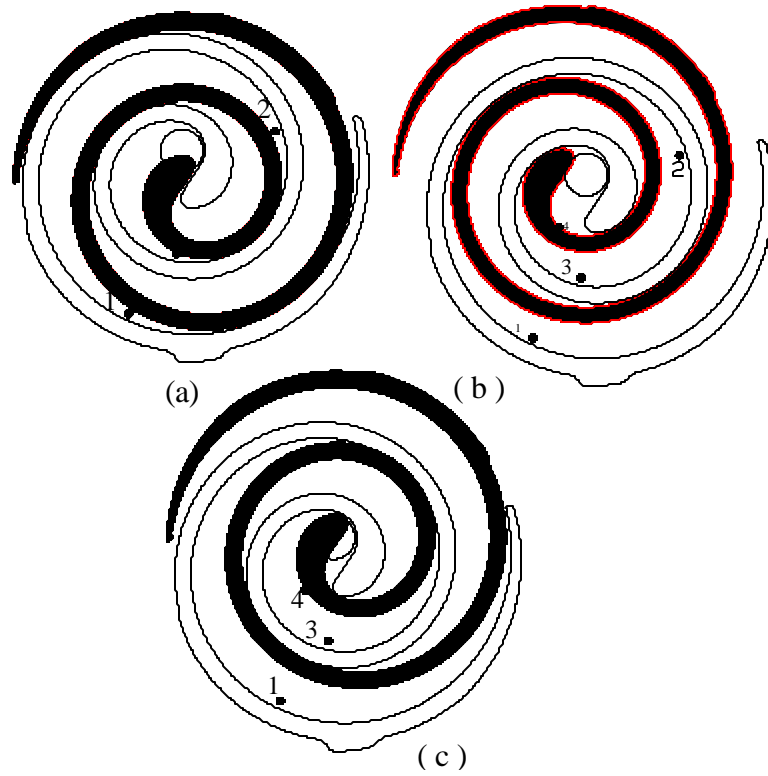

Fig. 4 Position of the pressure sensors and movement of the orbit scroll

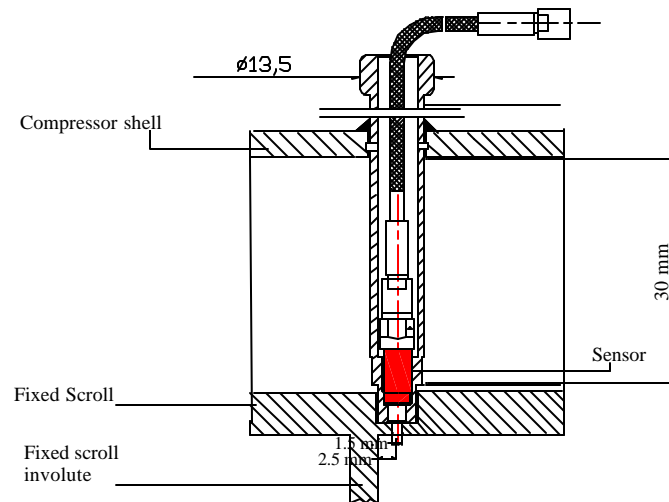

Fig. 5 Mounting sleeve



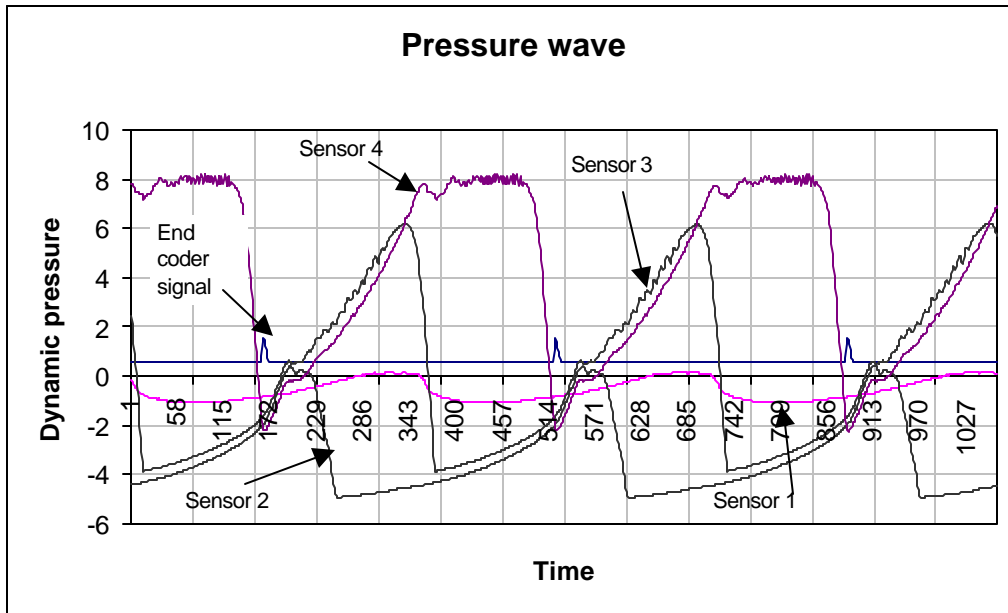

Fig. 6 Pressure transducers measurements (dynamic)

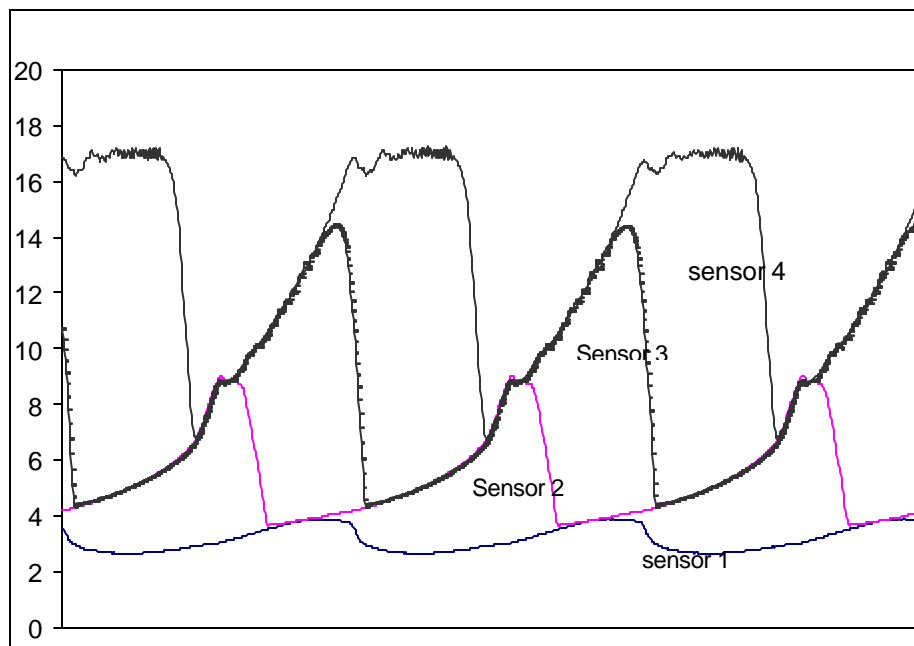

Fig.7 Pressure transducers measurements (absolute)

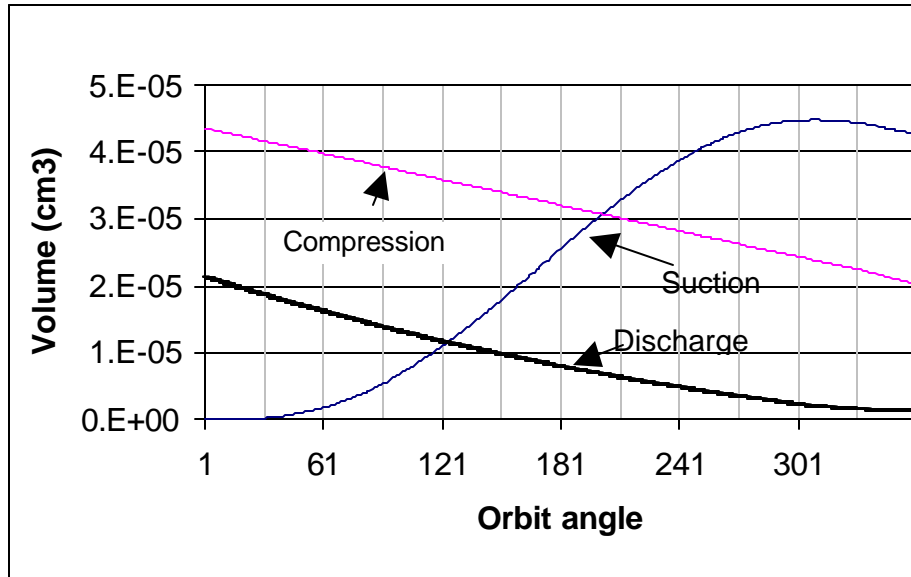

Fig.8 Variations of evaluated volumes of Suction,Compression and Discharge

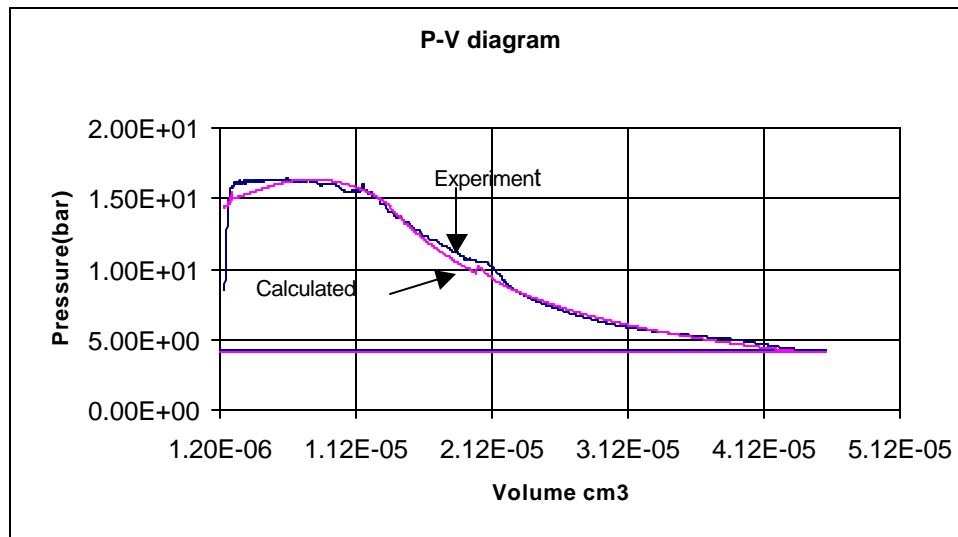

Fig.9 Pressure - Volume diagram

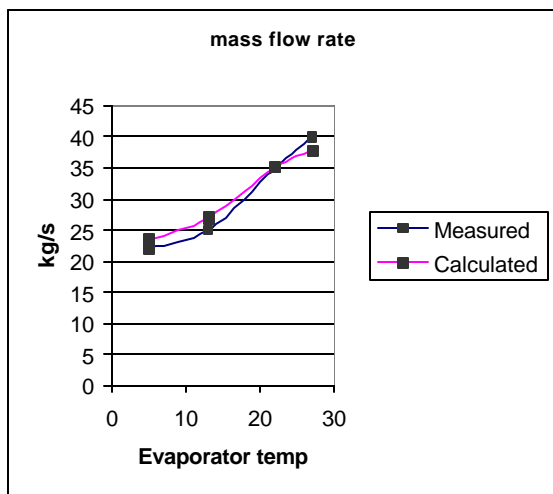

Fig.10 Calculated and experimental mass flow rates

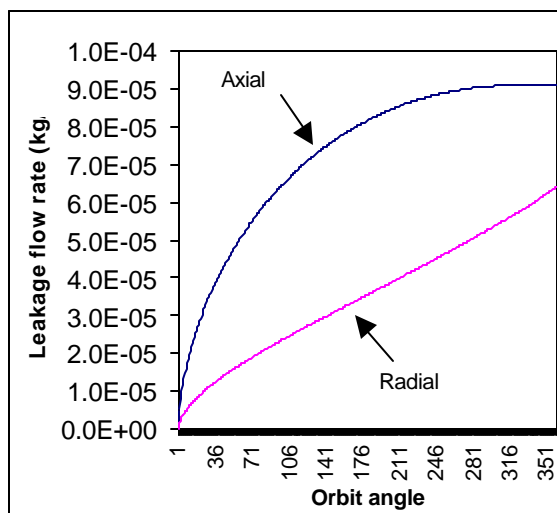

Fig.11 Calculated leakage flow rate from compression to suction

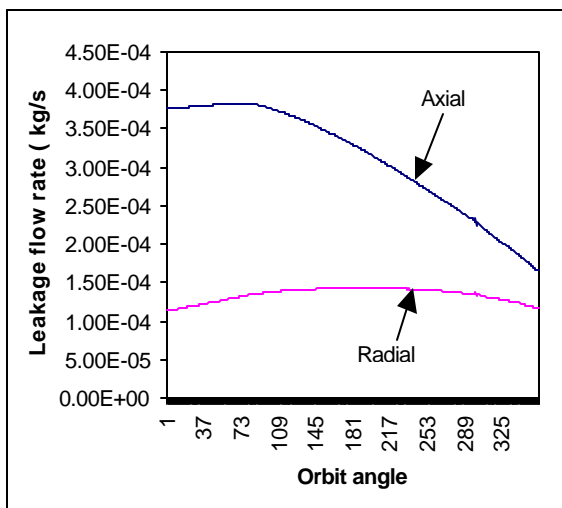

Fig.12 Calculated leakage flow rate from discharge to compression

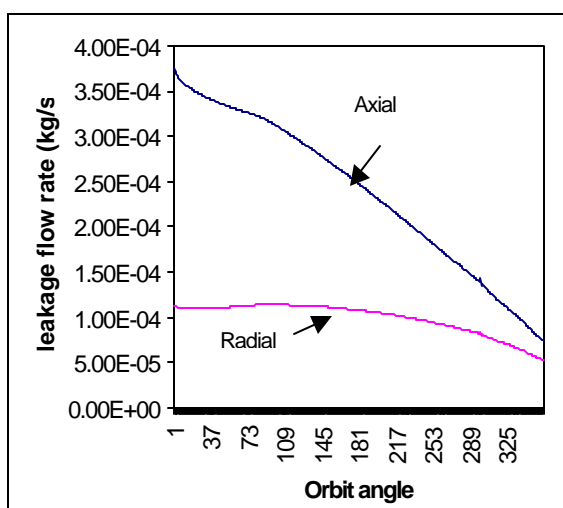

Fig.13 Total leakage into the compression pocket

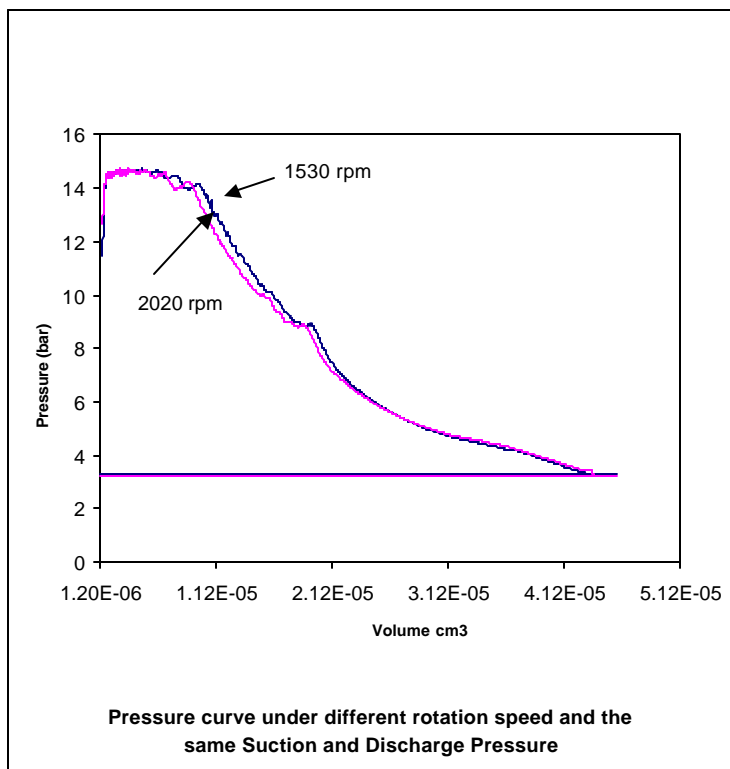

Fig 14 Measurements pressures under different speed