

2016

# Experimental Comparison Of Different Composite Latent Heat Storage Devices With Spatially Non-Constant Heat Loads

Henrik Veelken

*Institute of Thermo-Fluid Dynamics, Hamburg University of Technology, Germany, henrik.veelken@tuhh.de*

Gerhard Schmitz

*Institute of Thermo-Fluid Dynamics, Hamburg University of Technology, Germany, schmitz@tuhh.de*

Follow this and additional works at: <http://docs.lib.purdue.edu/iracc>

---

Veelken, Henrik and Schmitz, Gerhard, "Experimental Comparison Of Different Composite Latent Heat Storage Devices With Spatially Non-Constant Heat Loads" (2016). *International Refrigeration and Air Conditioning Conference*. Paper 1637.  
<http://docs.lib.purdue.edu/iracc/1637>

This document has been made available through Purdue e-Pubs, a service of the Purdue University Libraries. Please contact [epubs@purdue.edu](mailto:epubs@purdue.edu) for additional information.

Complete proceedings may be acquired in print and on CD-ROM directly from the Ray W. Herrick Laboratories at <https://engineering.purdue.edu/Herrick/Events/orderlit.html>

## HFO1234ze(E) and HFC134a Flow Boiling Inside a 4mm Horizontal Smooth Tube

Giovanni A. LONGO\*, Simone MANCIN, Giulia RIGHETTI, Claudio ZILIO

University of Padova, Department of Management and Engineering  
I-36100 Vicenza, Italy

Phone: +39 444 998726, Fax: +39 444 998888, E-mail: tony@gest.unipd.it

\* Corresponding Author

### ABSTRACT

This paper presents the comparative analysis of HFO1234ze(E) and HFC134a during vaporisation inside a 4 mm smooth tube. The experimental tests were carried out at three different saturation temperatures (10, 15, and 20 °C) at increasing vapour quality up to incipient dryout to evaluate the specific contribution of heat flux, refrigerant mass flux, mean vapour quality, and saturation temperature (pressure). The heat transfer coefficients have a positive slope versus vapour quality and the slope increases with refrigerant mass flux and decreases with heat flux. Saturation temperature (pressure), refrigerant mass flux, and mean vapour quality have a remarkable impact on the frictional pressure drop of both HFO1234ze(E) and HFC134a whereas the effect of heat flux appears marginal or negligible. Convective boiling seems to be the prevailing heat transfer regime in the present experimental tests. HFO1234ze(E) exhibits heat transfer coefficients similar to HFC134a and slightly higher frictional pressure drops.

### 1. INTRODUCTION

Nowadays, the substitution of HFC134a with low GWP refrigerants is one of the most important challenges for refrigeration and air conditioning. The possible substitutes include natural refrigerants, such as HC600 (Butane) and HC600a (Isobutane), and also synthetic refrigerants, such as HFO1234yf and HFO1234ze(E). The HC refrigerants exhibit very low GWP, 3 and 4 for HC600a and HC600, respectively, good thermodynamic and transport properties, and pressure and volumetric performance very similar to HFC134a. The major drawback of HC refrigerants is their high flammability, being classified as class A3 according to ASHRAE (ASHRAE (2013)). Also some HFO refrigerants present mild flammability, being classified as class A2L (ASHRAE (2013)). In particular HFO1234ze(E) seems to be a very promising substitute for HFC134a, showing a GWP lower than 1 together with pressure and volumetric properties close to those of HFC134a.

Hossain *et al.* (2013) analyzed HFO1234ze(E) saturated boiling inside a 4.35 mm horizontal smooth tube with a saturation temperature from 5 to 10 °C, a refrigerant mass flux varying from 150 kg m<sup>-2</sup> s<sup>-1</sup> to 445 kg m<sup>-2</sup> s<sup>-1</sup> over the vapour quality range from 0.00 to 1.00. Refrigerant HFO1234ze(E) was compared against HFC32, HFC410A, and the zeotropic mixture HFO1234ze(E)/HFC32 (55/45 mass %). Grauso *et al.* (2013) investigated HFO1234ze(E) and HFC134a local heat transfer coefficients, frictional pressure drops, and flow regimes during vaporisation inside a 6 mm smooth tube. The saturation temperatures were varied between -2.9 °C and 12.1 °C, the mass fluxes between 146 and 520 kg m<sup>-2</sup> s<sup>-1</sup> and heat fluxes between 5.0 and 20.4 kW m<sup>-2</sup>. Kondou *et al.* (2013) studied HFO1234ze(E), HFC32, and the zeotropic mixture HFO1234ze(E)/HFC32 flow boiling in a 5.21 mm microfin tube at a saturation temperature of 10 °C with heat fluxes of 10 and 15 kW m<sup>-2</sup>, and mass fluxes from 150 to 400 kg m<sup>-2</sup> s<sup>-1</sup>. Diani *et al.* (2014) presented an experimental study of HFO1234ze(E) flow boiling inside a 3.4 mm ID microfin tube. The experimental measurements were performed at a constant saturation temperature of 30 °C, by varying the refrigerant mass velocity between 190 and 940 kg m<sup>-2</sup> s<sup>-1</sup>, the vapour quality from 0.2 to 0.99 at three different heat fluxes: 10, 25, and 50 kW m<sup>-2</sup>.

This paper presents the comparative analysis of HFC134a and HFO1234ze(E) during saturated flow boiling inside a 4 mm horizontal smooth tube: the effects of heat flux, refrigerant mass flux, mean vapour quality, and saturation temperature (pressure) are investigated separately to rank the superposed effects of different heat transfer regimes (nucleate boiling or/and forced convection boiling). 4 mm inside diameter tube is particularly interesting to investigate, as it ensures a consistent reduction of the refrigerant charge with no penalisation in heat transfer.

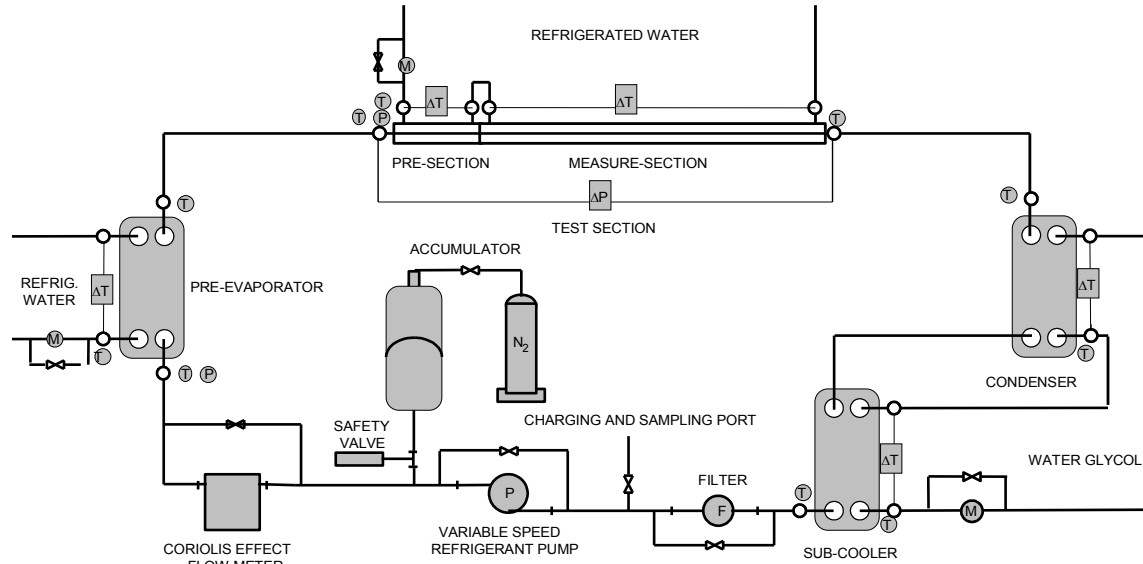
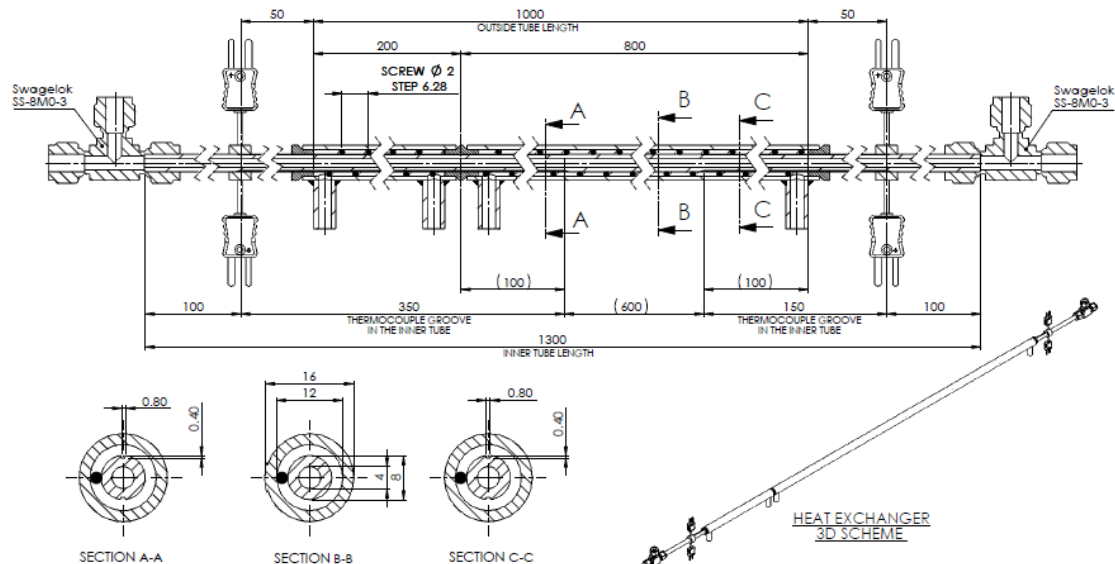

**Figure 1:** Schematic view of the experimental rig

## 2. EXPERIMENTAL MEASUREMENTS AND DATA REDUCTION

The experimental rig (see Figure 1) consists of three different loops: one for refrigerant and two for the secondary fluids (water and water-glycol solution). Table 1 summarises the characteristics of the measurement devices.

The test-section (see Figure 2) is a double tube evaporator in which the refrigerant evaporates in the inner tube while the refrigerated water flows in the annulus. The test-section is subdivided into two different parts: a pre-section, 200 mm long, in which the refrigerant flow achieves a fully developed flow regime and the measurement section, 800 mm long, in which the heat transfer coefficient is measured. This arrangement is obtained using a single inner smooth tube, 4 mm in diameter, 1300 mm long and two separated cooling water jackets fed in series. The inner tube is instrumented with four copper-constantan thermocouples (uncertainty ( $k = 2$ ) within  $\pm 0.1$  K) embedded in its wall to measure surface temperature. The thermocouples are inserted into two equidistant axial grooves, at the top and the bottom of the cross section, 100 mm from the inlet and outlet of the cooling water. Each groove is sealed with a copper wire fixed by epoxy. Table 2 shows the main geometrical characteristics of the test section including also the measured surface roughness of the tube.



**Figure 2:** Schematic view of the test section

**Table 1:** Specification of the different measuring devices

Device	Type	Uncertainty (k= 2)	Range
Thermometer	T-type thermocouple	0.1 K	-20 / 80°C
Differential thermometer	T-type thermopile	0.05 K	-20 / 80°C
Abs. pressure transducer	Strain-gage	0.075% f.s.	0 / 1.0 MPa
Diff. pressure transducer	Strain-gage	0.075% f.s.	0 / 0.3 MPa
Refrigerant flow meter	Coriolis effect	0.1% measured value	0 / 100 kg/h
Water flow meter	Magnetic	0.15% f.s.	100 / 1200 l/h

The experimental results are reported in terms of refrigerant-side heat transfer coefficients  $h_r$  and frictional pressure drops  $\Delta p_f$ .

The average heat transfer coefficient on the refrigerant side  $h_r$  is equal to the ratio between the heat flow rate  $Q$ , the heat transfer area  $A$ , and the mean temperature difference  $\Delta T$ :

$$h_r = Q / (A \Delta T) \quad (1)$$

The heat flow rate  $Q$  is derived from a thermal balance on the water-side of the measurement section, the heat transfer area  $A$  of the measurement section is equal to the area of the inner surface of the test tube, and the mean temperature difference  $\Delta T$  is equal to the difference between the average saturation temperature, derived from the average pressure on refrigerant side, and the arithmetical mean value of the readings of the four thermocouples embedded in the tube wall.

The frictional pressure drop on the refrigerant side  $\Delta p_f$  is computed by subtracting the inlet / outlet local pressure drops  $\Delta p_c$ , and the momentum pressure drops  $\Delta p_a$  from the total pressure drop measured  $\Delta p_t$ :

$$\Delta p_f = \Delta p_t - \Delta p_c - \Delta p_a \quad (2)$$

Being the test section horizontal, no gravity pressure drops  $\Delta p_g$  occur.

A detailed description of the whole experimental rig, the measurement devices, the operating procedures and the data reduction technique is reported by Longo *et al.* (2015).

### 3. ANALYSIS OF THE EXPERIMENTAL RESULTS

Two sets of vaporisation tests with refrigerant and water counter-flow were carried out at three different saturation temperatures (10, 15, and 20 °C) at increasing vapour quality up to incipient dryout: the first set includes 146 HFO1234ze(E) vaporisation runs, while the second 123 HFC134a runs under similar operating conditions. Table 3 gives the main operating conditions in the measurement section under test: refrigerant average saturation temperature  $T_{sat}$  and pressure  $p_{sat}$ , mean vapour quality  $X_m$ , refrigerant mass flux  $G$ , and heat flux  $q$ . A detailed error analysis performed in accordance with Kline and McClintock (1953) indicates an overall uncertainty within  $\pm 13.4\%$  and  $\pm 10.0\%$  for the refrigerant heat transfer coefficient measurement and within  $\pm 7.0\%$  and  $\pm 6.5\%$  for the total pressure drop measurement of HFO1234ze(E) and HFC134a, respectively.

**Table 2:** Geometrical characteristics of the tubular test section

Parameter	
Tube inside diameter $d$ (mm)	4.0
Measurement section length $L$ (mm)	800.0
Pre-section length (mm)	200.0
Total section length (mm)	1300.0
Inside tube surface roughness $R_a$ ( $\mu\text{m}$ ) (ISO 4287/1)	0.7
Inside tube surface roughness $R_p$ ( $\mu\text{m}$ ) (DIN 4762/1)	1.8

**Table 3:** Operating conditions during experimental tests

Fluid	Runs	$T_{\text{sat}} (\text{°C})$	$p_{\text{sat}} (\text{MPa})$	$X_m$	$G (\text{kg m}^{-2} \text{s}^{-1})$	$q (\text{kW m}^{-2})$
HFO1234ze(E)	146	9.8–20.2	0.30-0.43	0.08–0.97	196.2-607.0	10.1–30.6
HFC134a	123	9.9–20.2	0.41-0.57	0.11-0.96	200.7-610.4	10.3-30.5

The dominant heat transfer regimes in flow boiling inside smooth tubes are nucleate boiling and forced convection boiling. In nucleate boiling the heat transfer coefficients show a great sensitivity to heat flux, whereas in convection boiling they depend mainly on mass flux and vapour quality. Therefore the experimental tests were carried out in order to separate the contribution of heat flux, refrigerant mass flux, and mean vapour quality. At each saturation temperature (pressure) and constant refrigerant mass flow rate ( $G = 400 \text{ kg m}^{-2} \text{ s}^{-1}$ ), four different heat fluxes ( $q = 15, 20, 25, \text{ and } 30 \text{ kW m}^{-2}$ ) were applied at increasing mean vapour quality up to incipient dryout for the refrigerants tested. Then, at each saturation temperature (pressure) and constant heat flux ( $q = 20 \text{ kW m}^{-2}$ ), four different refrigerant mass fluxes ( $G = 200, 300, 400, \text{ and } 600 \text{ kg m}^{-2} \text{ s}^{-1}$ ) were applied at increasing mean vapour quality up to incipient dryout both for HFO1234ze(E) and HFC134a refrigerants.

Figures 3a and 3b show the average heat transfer coefficient on the refrigerant side  $h_r$  against mean vapour quality  $X_m$  at constant heat flux ( $q = 20 \text{ kW m}^{-2}$ ) and four different refrigerant mass fluxes ( $G = 200, 300, 400, \text{ and } 600 \text{ kg m}^{-2} \text{ s}^{-1}$ ), for HFO1234ze(E) and HFC134a at  $10 \text{ °C}$  of saturation temperature. The heat transfer coefficients have a positive slope versus vapour quality and the slope increases with refrigerant mass flux for both the refrigerants tested indicating a dominant effect of convective boiling mechanisms.

Figures 4a and 4b show the average heat transfer coefficient on the refrigerant side  $h_r$  against mean vapour quality  $X_m$  at constant refrigerant mass flux ( $G = 400 \text{ kg m}^{-2} \text{ s}^{-1}$ ) and four different refrigerant heat fluxes ( $q = 15, 20, 25, \text{ and } 30 \text{ kW m}^{-2}$ ), for HFO1234ze(E) and HFC134a refrigerants, at  $10 \text{ °C}$  of saturation temperature. The heat transfer coefficients have a positive slope versus vapour quality and the slope decreases with heat flux for both the refrigerants confirming the dominant effect of convective boiling mechanisms. Only in the region at low vapour quality persists a relevant contribution of nucleate boiling as proved by the positive dependence of the heat transfer coefficients on heat flux. HFO1234ze(E) exhibits heat transfer coefficients 10-20% lower than HFC134a at low vapour quality and 0-10% higher at high vapour quality. Therefore, on the whole range of vapour quality tested, HFO1234ze(E) and HFC134a present heat transfer coefficients that are very similar. The dryout occurs at the end of the measurement section for a mean vapour quality ranging from 0.66 to 0.85 depending on saturation temperature (pressure), heat flux, and refrigerant mass flux both for HFO1234ze(E) and HFC134a.

The above experimental results, in terms of prevailing contribution of convective boiling for the present test conditions and of the dryout onset, are in fair agreement with the Kim and Mudawar (2014) review on databases and predictive methods for flow boiling that included 18 working fluids, hydraulic diameters of 0.19 mm – 6.5 mm, mass velocities of  $19 \text{ kg m}^{-2} \text{ s}^{-1} - 1608 \text{ kg m}^{-2} \text{ s}^{-1}$ .

The heat transfer coefficients determined by the present experiment were compared against different heat transfer correlations for boiling inside tubes. The universal correlation proposed by Kim and Mudawar (2014) shows the best performance with a mean absolute percentage deviation of 6.1% both for HFO1234ze(E) and HFC134a data, respectively. Figure 5 shows the deviation between the experimental data and the calculated data by Kim and Mudawar (2014) universal correlation. This correlation predicts very well the experimental data both in trend and magnitude.

Figures 6a and 6b show the saturated boiling frictional pressure drop against refrigerant mass flux for HFO1234ze(E) and HFC134a, respectively. HFO1234ze(E) exhibits frictional pressure drops from 10 to 25% higher than those of HFC134a under the same operating conditions. HFO1234ze(E) and HFC134a saturation temperature (pressure), refrigerant mass flux, and mean vapour quality have a remarkable impact on the frictional pressure drop of both HFO1234ze(E) and HFC134a whereas the effect of heat flux appears marginal or negligible.

The present experimental data points were compared against different correlation for two-phase pressure drop inside tube. Friedel (1979) correlation shows the best performance with a mean absolute percentage deviation of 11.7 and 12.6 for HFO1234ze(E) and HFC134a, respectively. Figure 7 shows the deviation between the experimental data and the calculated data by Friedel (1979) correlation.

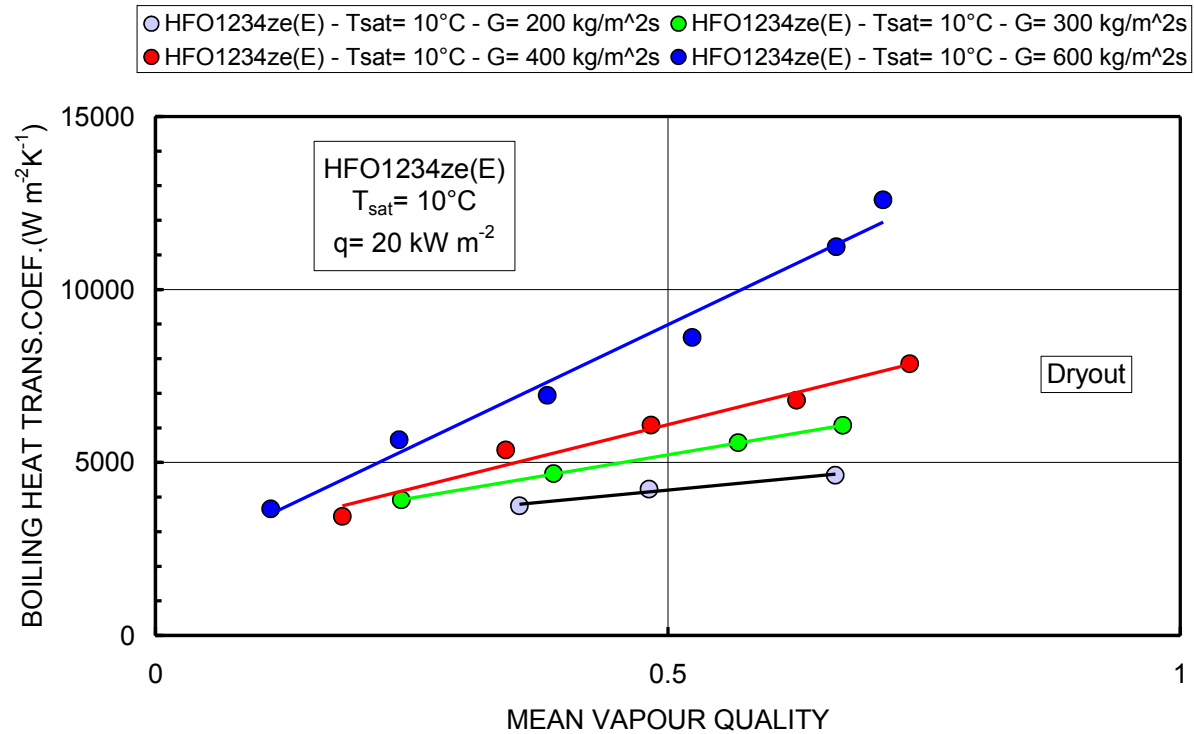

**Figure 3a:** Average heat transfer coefficient on refrigerant side vs. mean vapour quality and refrigerant mass flux at  $10^\circ\text{C}$  of saturation temperature and  $20 \text{ kW m}^{-2}$  of heat flux for HFO1234ze(E)

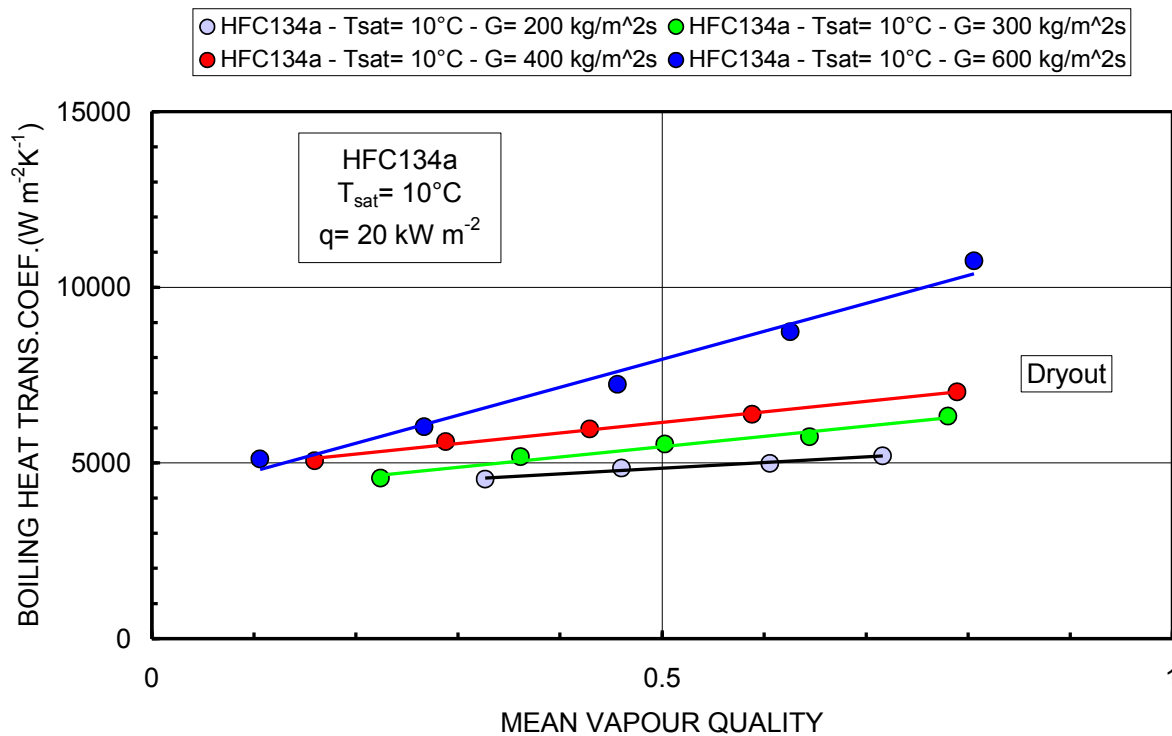

**Figure 3b:** Average heat transfer coefficient on refrigerant side vs. mean vapour quality and refrigerant mass flux at  $10^\circ\text{C}$  of saturation temperature and  $20 \text{ kW m}^{-2}$  of heat flux for HFC134a

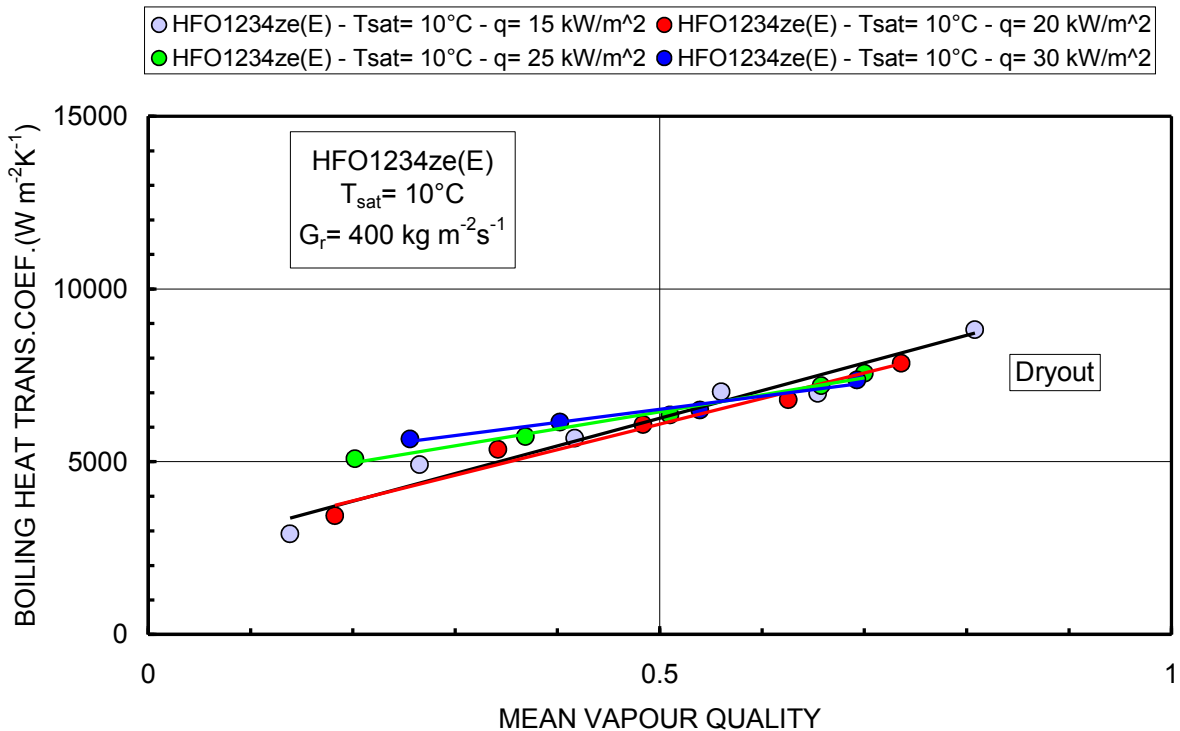

**Figure 4a:** Average heat transfer coefficient on refrigerant side vs. mean vapour quality and heat flux at 10°C of saturation temperature and 400 kg m<sup>-2</sup> s<sup>-1</sup> of refrigerant mass flux for HFO1234ze(E)

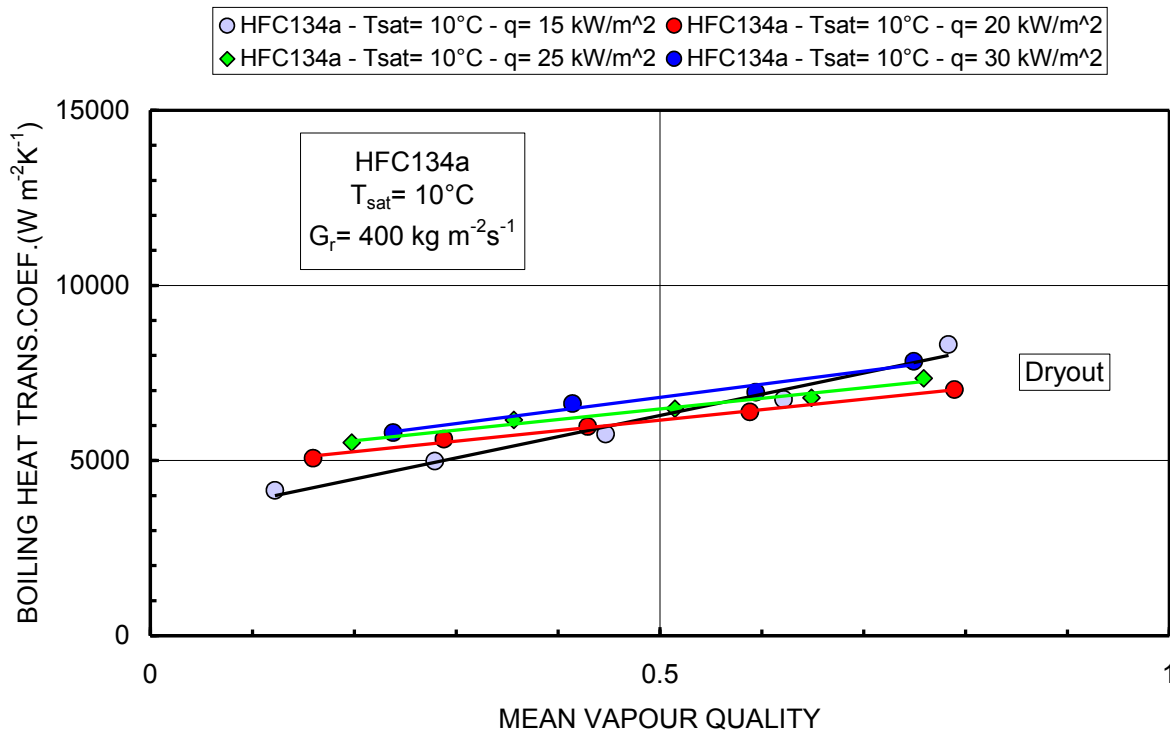

**Figure 4b:** Average heat transfer coefficient on refrigerant side vs. mean vapour quality and heat flux at 10°C of saturation temperature and 400 kg m<sup>-2</sup> s<sup>-1</sup> of refrigerant mass flux for HFC134a

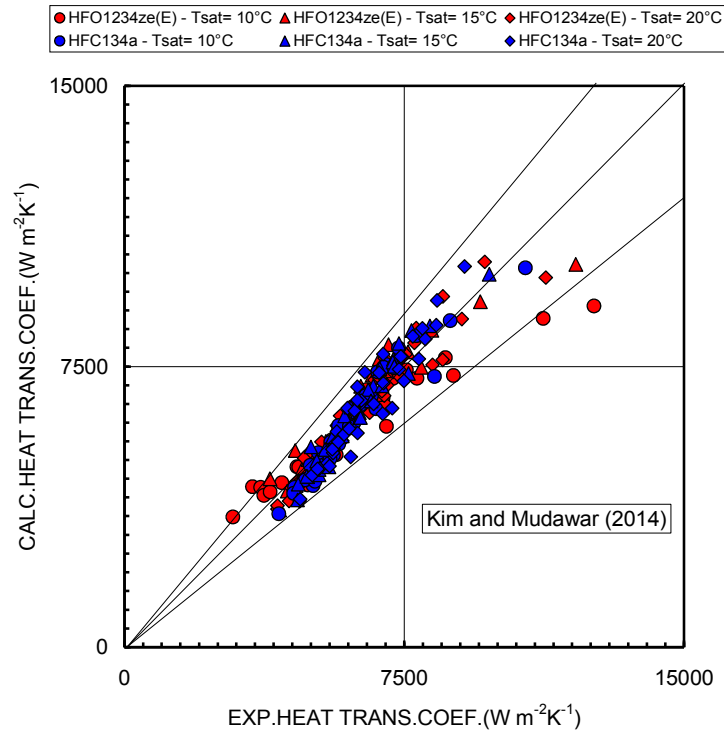

Figure 5: Comparison between experimental and calculated saturated boiling heat transfer coefficient by Kim and Mudawar (2014) universal correlation

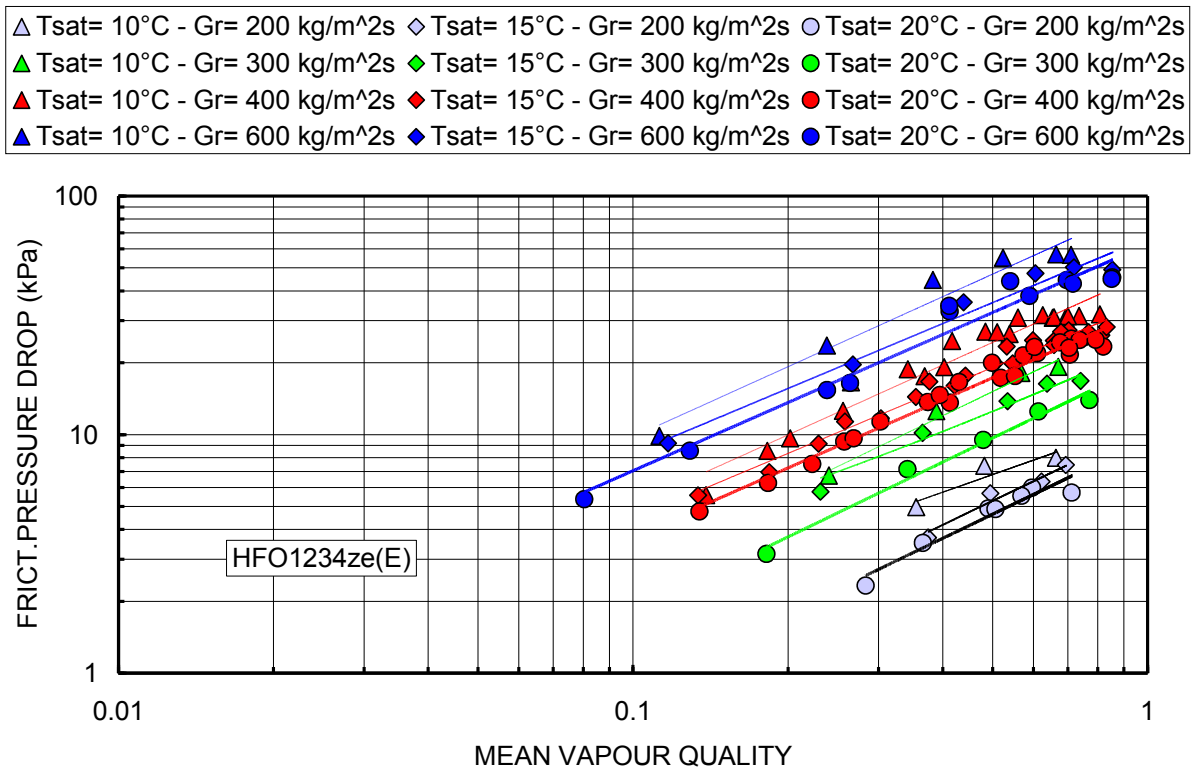
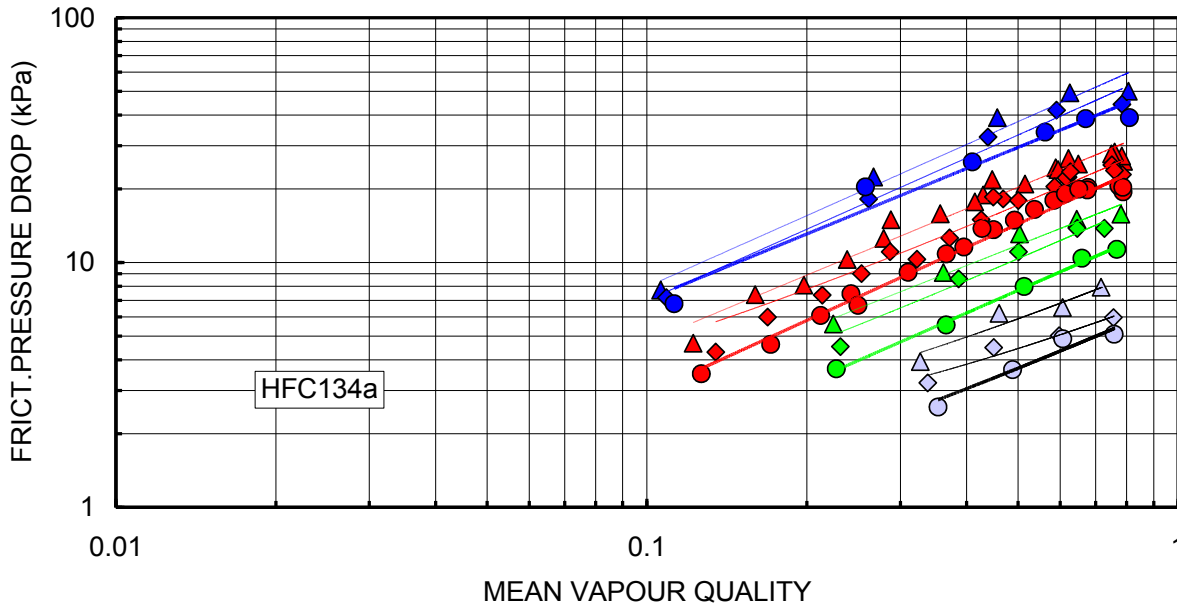
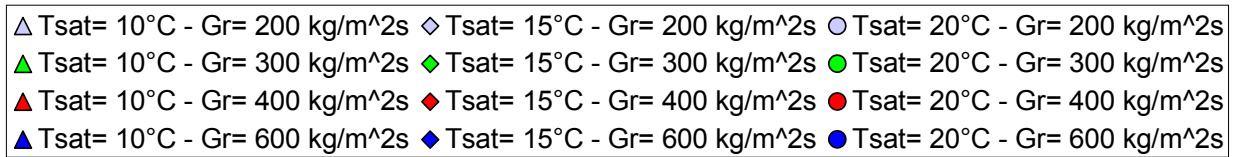
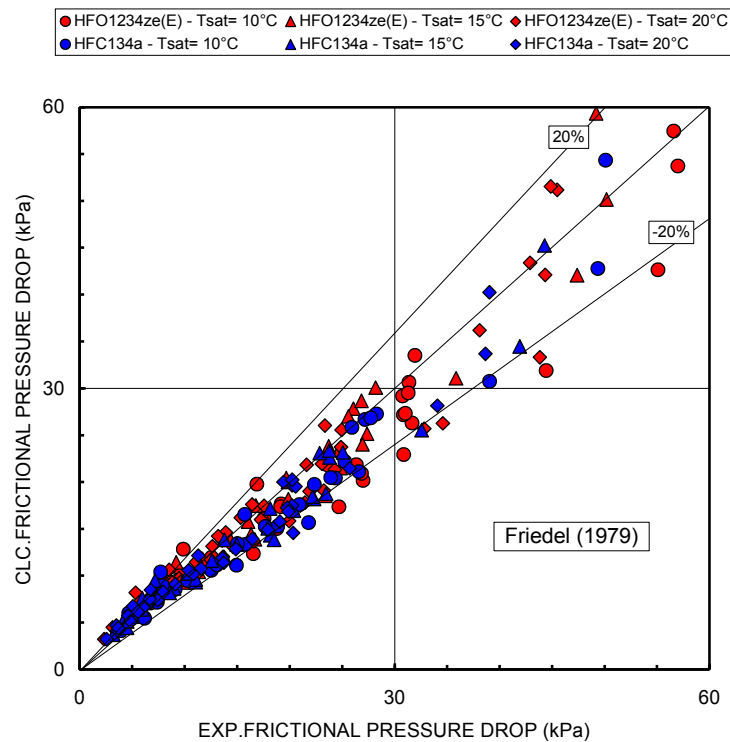

Figure 6a: Saturated boiling frictional pressure drop vs. refrigerant mass flux for HFO1234ze(E)





**Figure 6b:** Saturated boiling frictional pressure drop vs. refrigerant mass flux for HFC134a



**Figure 7:** Comparison between experimental and calculated frictional pressure drops by Friedel (1979) correlation

## 4. CONCLUSIONS

This paper presents the comparative analysis of HFO1234ze(E) and HFC134a during vaporisation inside a 4 mm horizontal smooth tube: the effect of heat flux, refrigerant mass flux, mean vapour quality, and saturation temperature (pressure) are evaluated separately.

The heat transfer coefficients have a positive slope versus vapour quality and the slope increases with refrigerant mass flux and decreases with heat flux. This trend is particularly evident for HFO1234ze(E) at 10°C. Convective boiling seems to be the dominant heat transfer regime in present experimental tests.

HFO1234ze(E) and HFC134a frictional pressure drops show great sensitivity to saturation temperature (pressure), refrigerant mass flux and mean vapour quality and weak or no sensitivity to heat flux.

HFO1234ze(E) exhibits heat transfer coefficients similar and frictional pressure drops 10 - 25% higher than those of HFC134a at the same operating conditions.

The present experimental heat transfer measurements confirm that HFO1234ze(E) is a very promising low GWP candidate for HFC134a replacement.

## NOMENCLATURE

$A$	heat transfer area of the measurement section	(m <sup>2</sup> )
$d$	tube diameter	(m)
f.s.	full scale	
$G$	refrigerant mass flux kg	(m <sup>2</sup> s <sup>-1</sup> )
$h$	heat transfer coefficient	(W m <sup>-2</sup> K <sup>-1</sup> )
$J$	specific enthalpy	(J kg <sup>-1</sup> )
$k$	coverage factor	
$L$	length of the measurement section	(m)
$p$	pressure	(Pa)
$q$	heat flux	( $q = Q / A$ , W m <sup>-2</sup> )
$Q$	heat flow rate	(W)
$R_a$	arithmetic mean roughness (ISO4271/1)	(μm)
$R_p$	roughness (DIN 4762/1)	(μm)
$T$	temperature	(K, °C)
$X$	vapour quality, $X = (J - J_L) / \Delta J_{LG}$	

### Greek symbol

$\Delta$	difference	
$\Delta J_{LG}$	latent heat of vaporisation,	(J kg <sup>-1</sup> )

### Subscript

a	momentum
c	local
f	frictional
g	gravity
LG	liquid vapour phase change
m	mean value
r	refrigerant
t	total
sat	saturation

## REFERENCES

- ASHRAE 15-2013 - Safety Standard for Refrigeration Systems and Designation and Classification of Refrigerants
- Diani, A., Mancin, S., Rossetto, L. 2014. R1234ze(E) flow boiling inside a 3.4 mm ID microfin tube. *Int. J. Refrigeration*, 47, 105-119.
- Friedel, L., 1979. Improved friction pressure drop correlations for horizontal and vertical two-phase pipe flow, European Two-Phase Group Meeting, Ispra, Italy, Paper E2.
- Grauso, S., Mastrullo, R., Mauro, A.W., Thome, J.R., Vanoli, G.P., 2013. Flow pattern map, heat transfer and pressure drops during evaporation of R-1234ze(E) and R134a in a horizontal, circular smooth tube: Experiments and assessment of predictive methods. *Int. J. Refrigeration* 36, 478-491.
- Hossain, A., Onaka, Y., Afroz, H., Miyara, A., 2013. Heat transfer during evaporation of R1234ze(E), R32, R410A and a mixture of R1234ze(E) and R32 inside a horizontal smooth tube. *Int. J. Refrigeration* 36, 465–477.
- Kim, S.M., Mudawar, I., 2014. Review of databases and predictive methods for heat transfer. *Int. J. Heat Mass Trans.*, 77, 627–652
- Kline, S.J., McClintock, F.A., 1953. Describing uncertainties in single-sample experiments. *Mech.Eng.*, 75, 3–8.
- Kondou, C., BaBa, D., Mishima, F., Koyama, S., 2013. Flow boiling of non-azeotropic mixture R32/R1234ze(E) in horizontal microfin tubes. *Int. J. Refrigeration*, 36, 2366-2378.
- Longo, G.A., Mancin, S., Righetti, G., Zilio, C., 2016. HFC32 and HFC410A flow boiling inside a 4mm horizontal smooth tube. *Int. J. Refrigeration*, 61, 12–22

## ACKNOWLEDGEMENT

This research project was partially funded by:

CariVerona Foundation, Verona, Italy, Ricerca Scientifica e Tecnologica 2013-2014:

*“Sviluppo di innovativi processi a ridotto impatto ambientale per la conservazione e distribuzione a bassa temperatura delle derrate alimentari a salvaguardia della salute”.*