

2004

Introduction of Transcritical Refrigeration Cycle Utilizing CO₂ as Working Fluid

Haruhisa Yamasaki
Sanyo Electric Co.

Masaji Yamanaka
Sanyo Electric Co.

Kenzo Matsumoto
Sanyo Electric Co.

Gaku Shimada
Sanyo Electric Co.

Follow this and additional works at: <https://docs.lib.purdue.edu/icec>

Yamasaki, Haruhisa; Yamanaka, Masaji; Matsumoto, Kenzo; and Shimada, Gaku, "Introduction of Transcritical Refrigeration Cycle Utilizing CO₂ as Working Fluid" (2004). *International Compressor Engineering Conference*. Paper 1632.
<https://docs.lib.purdue.edu/icec/1632>

This document has been made available through Purdue e-Pubs, a service of the Purdue University Libraries. Please contact epubs@purdue.edu for additional information.

Complete proceedings may be acquired in print and on CD-ROM directly from the Ray W. Herrick Laboratories at <https://engineering.purdue.edu/Herrick/Events/orderlit.html>

INTRODUCTION OF TRANSCRITICAL REFRIGERATION CYCLE UTILIZING CO₂ AS WORKING FLUID

Haruhisa YAMASAKI¹, Masaji YAMANAKA¹
Kenzo MATSUMOTO¹, Gaku SHIMADA²

SANYO Electric Co., Ltd., Clean Energy Company,
¹CO₂ Compressor Business Unit
²Compressor W.W.CRM Business Unit
1-1-1 Sakata Oizumi-machi Ora-gun Gunma, Japan
E-mail: yamasaki12@sm.energy.sanyo.co.jp

ABSTRACT

This paper describes the transcritical refrigeration cycle utilizing CO₂ as working fluid which is composed with Gas cooler, Inter cooler, Suction Line Heat Exchanger, Capillary tube and Rolling Piston type 2-Stage CO₂ Compressor. The adoption of the Inter cooler between 1st discharge and 2nd suction reduced the 2nd discharge gas temperature. The adoption of the Suction Line Heat Exchanger enabled to have a sufficient superheat of 1st suction. The adoption of capillary tube as an expansion device helped the system simplicity.

The better cycle efficiency level was achieved with CO₂ cycle compared with that of conventional cycle for the application of refrigeration equipment.

1. INTRODUCTION

Due to global environmental concerns, the usage of natural working fluid is becoming more interesting theme to be discussed. Transcritical CO₂ cycle is recently considered as one of the most influential refrigerant for its characteristics such as non-ODP, negligible GWP, non-flammability and non-toxicity, despite the drawback of high working pressure.

Practically, CO₂ have been used for cascade cycles CO₂/Propane⁽¹⁾ and CO₂/NH₃⁽²⁾. As direct expansion cycles utilizing transcritical CO₂, Heat Pump Water Heaters were commercialized in Japan⁽³⁾. Sanyo is one of the manufacturers that commercialized CO₂ compressor and its applied Heat Pump Water Heater since 2001. However, not so many studies were reported on transcritical CO₂ cycle that is applied for refrigerator or freezer⁽³⁾.

For years, authors studied the application of transcritical CO₂ cycle for refrigeration. As an example, the application for commercial refrigeration equipment was pursued, because non-HFC technology is demanded and the non-flammability is considered to be seriously important as they are often placed in public and asked safety for.

In this paper, the idea of transcritical CO₂ refrigeration cycle with Rolling Piston type 2-Stage CO₂ Compressor for middle range evaporating temperature refrigeration equipment is presented. Cooling performance and power consumption of CO₂ cycle are compared with those of conventional R134a cycle.

2. CO₂ COMPRESSOR

2.1 Characteristics of 2-Stage CO₂ Compressor

Properties of CO₂ are as follows.

- The pressure ratio in the transcritical CO₂ refrigeration cycle is rather low, while the pressure difference is high compared to conventional HFCs refrigeration cycle.

- Transcritical CO₂ refrigeration cycle has high operation pressure.

Considering those properties, following ideas were suggested for CO₂ compressor.

- (1) Rolling Piston type 2-Stage CO₂ Compression Mechanism
- (2) Internal Intermediate Pressure Structure and Entirely Hermetic Shell Design.

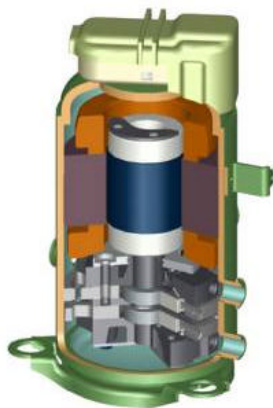

Figure1: CO₂ Compressor

Table 1: Example of CO₂ Compressor Specifications

Power source	Single Phase 230V/50Hz
Rated Input	400W
Displacement	1 st stage : 1.28 cm ³ 2 nd stage : 0.83 cm ³
Motor Type	Induction Motor (Single Speed)
OIL	PAG

2.2 Rolling Piston type 2-Stage CO₂ Compression Mechanism

In order to apply to the high pressure-difference, 2-stage compression mechanism was adopted. By dividing the compression load into 2 compressions, the leakage at the seal is reduced so that high compression efficiency can be attained⁽⁵⁾.

In addition, two pistons placed 180 deg opposite side give low vibration and low noise. By CO₂ properties, high volumetric efficiency with small piston size was achieved so that the rotational inertia and torque balance become small, which contributes the smooth shaft rotation at start up and operation.

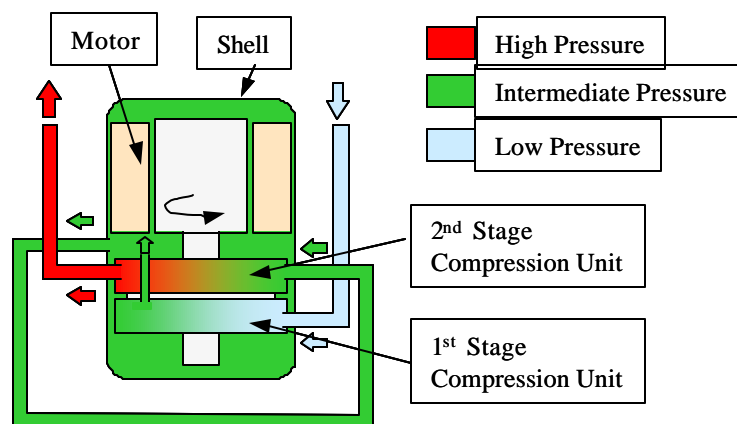

Figure2: Schematic View of a 2-stage Compression Mechanism

2.3 Internal Intermediate Pressure Structure and Entirely Hermetic Shell Design

1st stage compression unit intakes the low pressure CO₂, compresses, and discharges intermediate pressure into a shell, so that the shell is filled with intermediate pressure. From the shell, the intermediate CO₂ is discharged out to the cycle and returns to 2nd stage compression unit, which compresses up to final pressure and discharged to the Gas cooler directly.

Internal intermediate pressure design enabled the shell wall thickness to be 35% thinner than that of high internal pressure structure design. This contributes the low weight that is almost same as conventional R410A compressor. In addition, internal intermediate pressure design makes the pressure difference during the compressor run/stop smaller than that of high internal pressure design. This brings the high reliability against the fatigue of the shell material by the repetition of high/low pressures cycle.

3. TRANSCRITICAL CO₂ CYCLE

To improve transcritical CO₂ cycle efficiency, various cycles are studied that using Inter cooler⁽⁶⁾, using Suction Line Heat Exchanger (SLHX) and Microchannel heat exchanger, etc.

Items in the cycle;

- (1) Heat Exchanger (Gas cooler, Evaporator)
- (2) Suction Line Heat Exchanger (SLHX)
- (3) Inter Cooler
- (4) Expansion Device

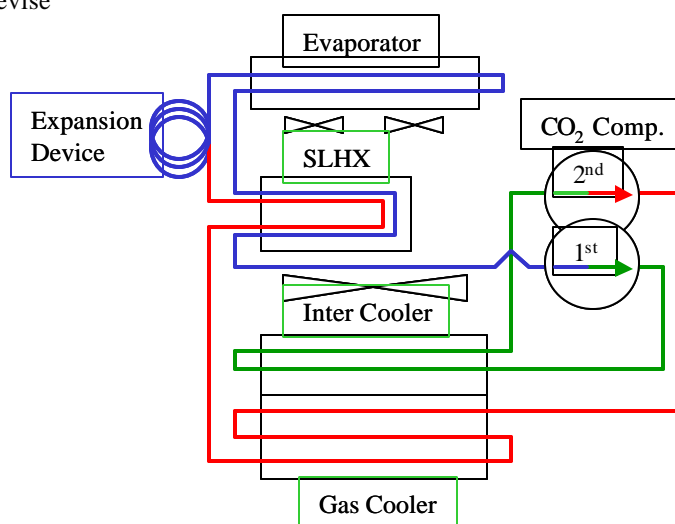

Figure 3: Example of Transcritical CO₂ Cycle

3.1 Heat Exchanger (Gas Cooler & Evaporator)

As of today, for Inter cooler, Gas cooler and Evaporator, fin and round tube type heat exchangers are more adopted in the conventional cycles because they are well available. Besides round tube heat exchangers, microchannel heat exchangers are most feasible option because CO₂ has less pressure drop. Microchannel heat exchangers have the potential to enhance the performance, and reduce size and weight.

3.2 Suction Line Heat Exchanger (SLHX)

SLHX improves an efficiency of refrigeration cycle. The cooling effects of cycle with/without SLHX are shown equations (1), (2) and figure 4. The cooling effect with SLHX is larger than that of without SLHX.

$$W_{withSLHX} = (h_1 - h_8) = (h_1 - h_4) + (h_4 - h_8) \quad (1)$$

$$W_{withoutSLHX} = (h_1 - h_4) \quad (2)$$

Obviously, the cycle with SLHX shows high discharge temperature because of heated suction gas. The discharge gas temperature may go up around 150C with SLHX at point 6 in figure 4. As the extensively high discharge temperature is not preferred for reliability of refrigeration cycle, any countermeasure should be conducted

for the practical usage of CO₂ cycle. Here, the adoption of Inter cooler is suggested not only to reduce the discharge temperature but also to extract performance by utilization of SLHX.

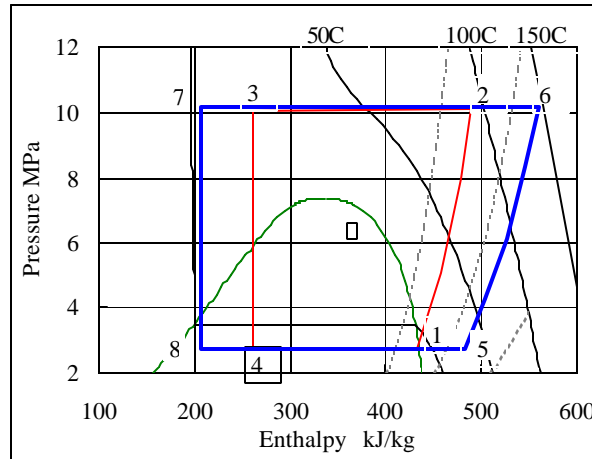

Figure 4: Pressure-Enthalpy diagram of CO₂ cycle with/without SLHX

3.3 Inter Cooler

The adoption of Inter cooler is one of the biggest merits of 2-stage compression in transcritical CO₂ cycle. The cycle utilizing SLHX and Inter cooler is shown as the 5-9-10-2-7-8-5 in figure 5. The final discharge temperature at point 2 can be even cooler than that of standard HFC cycle. This effect, as a merit of 2-stage compression with Inter cooler, becomes more outstanding and indispensable for lower evaporating temperature application such as freezer. The reduction of discharge temperature prevents to generate oxidation from oil and other organic compounds and is necessary to improve chemical durability in refrigeration cycle.

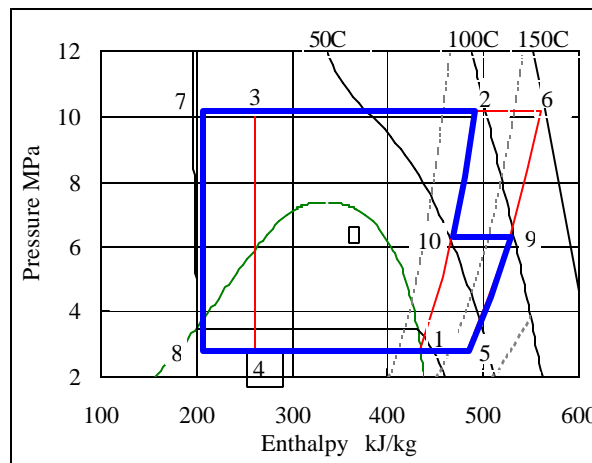

Figure 5: Pressure-Enthalpy diagram of CO₂ cycle with or without Inter cooler

The compression works with / without Inter cooler are given equations (3) and (4) in figure 5. The first and second terms on the right hand side of equation (3) stand for the compression works of the 1st stage and 2nd stage compression unit. In the transcritical region, due to the transcritical heat rejection of the isothermal, 2nd stage compression work with Inter cooler ($h_2 - h_{10}$) become smaller than that without Inter cooler ($h_6 - h_9$). Therefore, 2-stage compressor works better than single stage compressor from the viewpoint of compressor efficiency.

$$W_{withIC} = (h_9 - h_5) + (h_2 - h_{10}) \quad (3)$$

$$W_{withoutIC} = (h_6 - h_5) = (h_9 - h_5) + (h_6 - h_9) \quad (4)$$

The larger size of Inter cooler, the higher efficiency may be achieved. However, too much cooled 2nd suction gas that approaches saturated vapor line causes the liquid back to 2nd stage compression unit of CO₂ compressor, which may result the abrasive wear or valve damage because Rolling Piston type compressor has a direct-suction-mechanism. Therefore, size and location of Inter cooler need to be considered carefully.

3.5 Expansion Device

As an expansion device, capillary tube is extensively used because of its simplicity.

On the other hand, CO₂ Heat Pump Water Heater that is commercialized in Japan typically uses an electrically controlled expansion valve, which is suitable for application required the sensible control of hot water temperature.

Beside capillary tube and electrically controlled expansion valve, mechanical expansion valves that detect temperatures or pressures are also available. However, the durability against the high pressure of CO₂ must be considered well before adoption.

4. SYSTEM DESIGN

Because of refrigerant properties, it is considered to be very difficult to compare sub-critical refrigeration cycle of HFC with transcritical cycle of CO₂. The comparison of the cycle efficiency was evaluated in the same equipment installed both refrigeration cycles. For this study, the middle evaporating temperature equipment, which is originally installed R134a reciprocating compressor was used.

4.1 Heat Exchanger (Gas cooler and Evaporator)

In this paper, fin and round tube type heat exchangers were used for its good availability. The photos are shown in figure 6 and 7. Inter cooler is located above Gas cooler and shares the same fins.

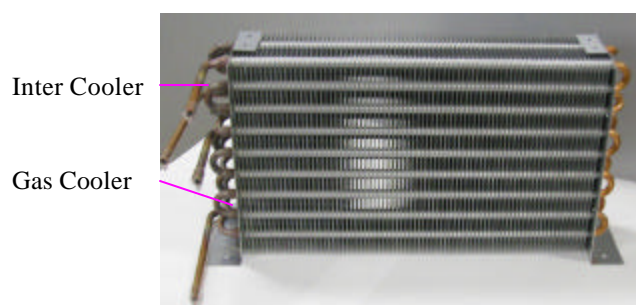

Figure 6: Gas cooler and Inter Cooler

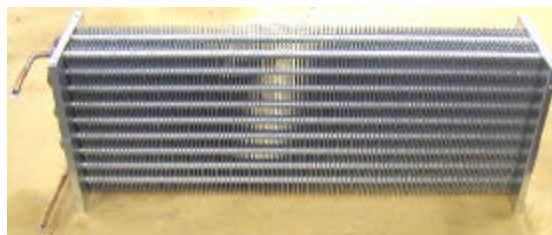

Figure 7: Evaporator

4.2 SLHX

As SLHX, tube in tube type heat exchanger was used because of its simplicity. The schematic view is shown in figure 8. High pressure CO₂ flows inside the smaller diameter tube and is cooled down by the counter flowed low pressure CO₂ inside the larger diameter tube.

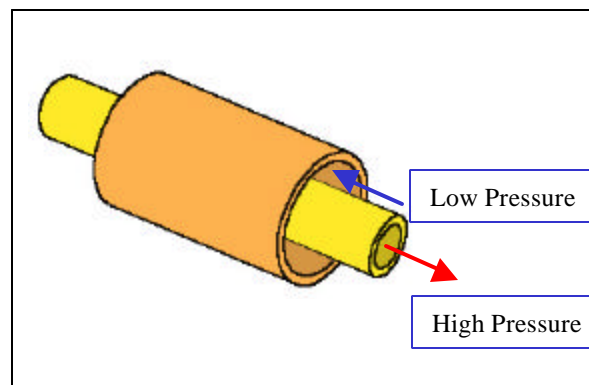

Figure 8 : Schematic view of Tube in Tube type SLHX

4.3 Inter Cooler

Though the efficiency of the cycle can be increased using the larger Inter cooler, 2nd suction after Inter cooler must be super heated to avoid liquid compression. Figure 9 shows the cycle under 0 C ambient temperature, which is considered to be the most severe condition to have super heat. As shown in figure 9, 2nd suction super heat was secured.

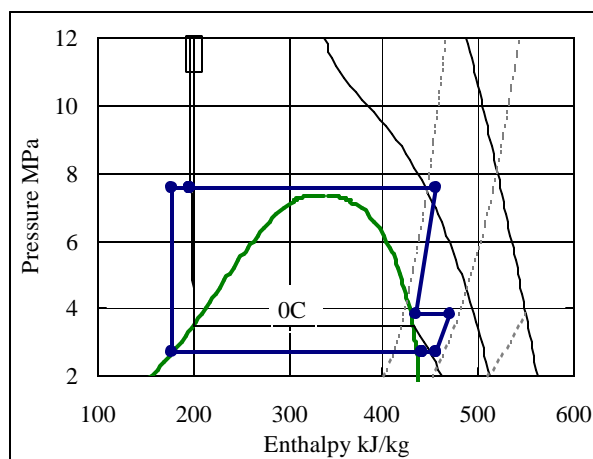

Figure 9: Pressure-Enthalpy diagram of CO₂ cycle with Inter cooler in low ambient temperature

4.4 Expansion Device

As expansion device, capillary tube is used for its good availability. The pressure overshoot was not seen at the start up and stable operation was confirmed.

4.5 Refrigeration Performance

To compare refrigeration performance of two different cycles, R134a and transcritical CO₂, the pull down time in the same refrigeration equipment under the same condition with different refrigeration unit was tested.

Figure 10 shows the result of pull down test of CO₂ and R134a cycles in the same cabinet. As pull down time of both cycles are almost same, the cooling performance of transcritical CO₂ cycle was verified to be almost same as that of R134a cycle.

Input	Single phase 230V 50Hz
Ambient	32.2 C
Humidity	65 %
Test Piece	Soft drinks

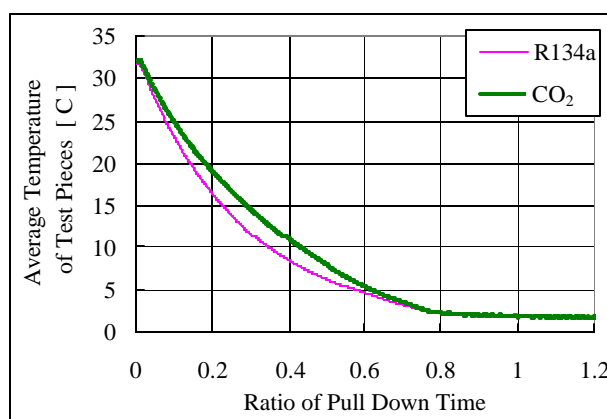

Figure 10: Pull Down performance of CO₂ and R134a cycle

4.6 Power Consumption

To compare power consumption of two different cycles, the power consumption under stabilized condition was evaluated. The result is shown in Figure 11.

The data in Figure 11 do not include power consumptions of fan motors and advertising lights. By this comparison, CO₂ compressor was confirmed to consume 20% less than R134a compressor. This result is contributed not only by CO₂ refrigerant property, but also by the adoption of Inter cooler, SLHX and the high performance of Rolling Piston type 2-stage CO₂ Compressor.

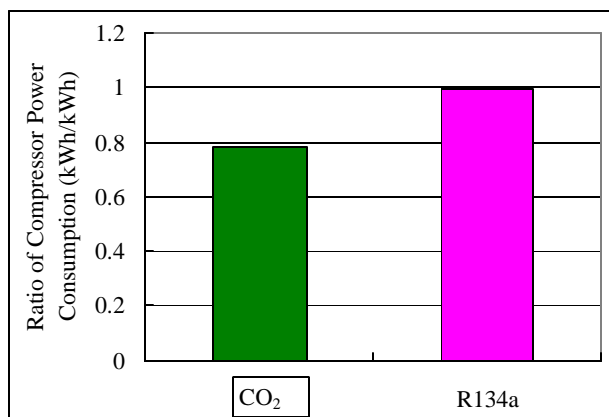

Figure 11 : Comparison of Power Consumptions

4.7 Durability Test

The durability tests of CO₂ refrigeration unit were conducted. The conditions were shown in the table 3. The condition of sliding parts' wear, capillary tube flow resistance, and total acid number of oil were investigated, and favorable results were attained. These favorable results were contributed by the discharge temperature reduction by utilization of Inter cooler.

Table 3: Durability Test Conditions

Evaporating Temperature	- 10 to - 5 C
2 nd Discharge Temperature	100 to 120 C
Test Period	Over 500 hours

5. CONCLUSIONS

The transcritical CO₂ refrigeration cycle was developed with Rolling piston type 2-stage compressor, Inter cooler, SLHX, and capillary tube. SLHX was examined and confirmed to extract high efficiency of CO₂ refrigeration cycle. The Inter cooler, which is applicable for 2-stage compressor, was confirmed to reduce the final discharge temperature. The capillary tube was examined as expansion device and stable operation was confirmed.

Transcritical CO₂ cycle was practically evaluated for many aspects of performance and reliability, and same level of cooling performance and 20% better efficiency was realized compared to the conventional R134a cycle. In addition, the reliability tests were conducted and favorable result were attained.

In the future, to utilize advanced technology such as microchannel heat exchangers, other expansion devices, and cycle improvement, will potentially enhance the efficiency of transcritical CO₂ cycle.

CO₂ transcritical cycle with 2-stage compressor is being confirmed to work in various applications.

REFERENCES

- (1) K. Christensen, 2003, Refrigeration systems in supermarkets with Propane and CO₂ – Energy Consumption and Economy, *International Congress of Refrigeration 2003*.
- (2) Akaboshi, Ikeda, 2003, CO₂/ NH₃ Cascade Refrigeration System (No.2), *Proceedings of the 37th Japanese Joint Conference on Air-conditioning and Refrigeration: p.41-45*.
- (3) H. Mukaiyama, 2002, Development of CO₂ Compressor and Its Application Systems, *7th International Energy Agency Heat Pump Conference*
- (4) S. Giroto, 2003, Commercial refrigeration system with CO₂ as refrigerant experimental results, *International Congress of Refrigeration 2003*.
- (5) Tadano, 2000, Development of the CO₂ hermetic Compressor, *Proceedings of the 4th IIR-Gustav Lorentzen Conference on Natural Working Fluids at Purdue, pp.323-330*.
- (6) B. Hubacher, A. Groll, 2003, Performance Measurements of a Hermetic Two-Stage Carbon Dioxide Compressor, *International Congress of Refrigeration 2003*