

2014

Study On Energy Conservation And Carbon Dioxide Emission Reduction Of Commercial Display Refrigerator Of Supermarket Utilizing The Exhaust Heat From The Novel Environment-Friendly Dispersed Power

Tatsuya Shikano

Department of Modern Mechanical Engineering/Waseda University, Japan, ngc6302@asagi.waseda.jp

Sangchul Bae

Environmental Research Institute/Waseda University, Japan, scbae@aoni.waseda.jp

Masafumi Katsuta

Department of Modern Mechanical Engineering/Waseda University, Japan, katsuta@waseda.jp

Tomohiro Anamizu

Graduate School of Modern Mechanical Engineering/Waseda University,, shooting.tm@suou.waseda.jp

Follow this and additional works at: <http://docs.lib.purdue.edu/iracc>

Shikano, Tatsuya; Bae, Sangchul; Katsuta, Masafumi; and Anamizu, Tomohiro, "Study On Energy Conservation And Carbon Dioxide Emission Reduction Of Commercial Display Refrigerator Of Supermarket Utilizing The Exhaust Heat From The Novel Environment-Friendly Dispersed Power" (2014). *International Refrigeration and Air Conditioning Conference*. Paper 1505.
<http://docs.lib.purdue.edu/iracc/1505>

This document has been made available through Purdue e-Pubs, a service of the Purdue University Libraries. Please contact epubs@purdue.edu for additional information.

Complete proceedings may be acquired in print and on CD-ROM directly from the Ray W. Herrick Laboratories at <https://engineering.purdue.edu/Herrick/Events/orderlit.html>

Study on Energy Conservation and Carbon Dioxide Emission Reduction of Commercial Display Refrigerator of Supermarket Utilizing the Exhaust Heat from the Novel Environment-Friendly Dispersed Power

Tatsuya SHIKANO¹, Sangchul BAE², Masafumi KATSUTA³, Tomohiro ANAMIZU⁴

¹ Waseda University, Department of Modern Mechanical Engineering, Tokyo, Japan, ngc6302@asagi.waseda.jp

² Waseda University, Environmental Research Institute, Saitama, Japan, scbae@aoni.waseda.jp

³ Waseda University, Department of Modern Mechanical Engineering, Tokyo, Japan, katsuta@waseda.jp

⁴ Waseda University, Department of Modern Mechanical Engineering, Tokyo, Japan, tomohacci.2110@hotmail.co.jp

ABSTRACT

Since the nuclear disaster was caused by the Great East Japan Earthquake in 2011, Japanese energy generation system has been expected to prioritize safety and trustworthiness. To meet this requirement, distributed power supply systems, such as gas engine, fuel cell, photovoltaic system, and solar heat, are considered to be one of solutions. By producing electricity, these systems generate thermal energy as a by-product, and by using exhaust heat as thermal energy, we can help to minimize the CO₂ emissions.

In this study, we aimed to conserve energy and to reduce carbon dioxide emission of supermarket to which installed a novel environment-friendly dispersed power.

At first, we divided energy consumption devices of a supermarket into four groups of lightning, air conditioning, refrigeration, hot water supply by purpose of usage and we measured the time changes of the energy consumption in each seasons. And we verified outside and inside air conditions, and the operation characteristics of individual energy consumption devices. The supermarket we measured, is located in Isesaki-city, the northern Kanto region in Japan. From this measurement, we understood that the annual energy consumption of refrigeration apparatus was about 60-70% of the total energy consumption of supermarket. It means that to reduce energy of the refrigeration apparatus greatly contributes to energy conservation of supermarket. Most of energy consumption apparatus of refrigeration apparatus of supermarket are refrigerated cabinets, and its power consumption highly depended on inside air enthalpy and outside air temperature.

When we install dispersed power into a certain facility, the biggest problem that should be solved is annual utilization rate increase in exhaust heat. Because the annual utilization rate increment of the exhaust heat was not guaranteed by using only for heating, we built small scale model of supermarket which was equipped environmental friendly dispersed power such as gas engine, solar cell, solar heat, and we examined this scale model supermarket for waste heat usage.

In this study, we tried to increase the degrees of supercooling at condenser exit of the refrigerated cabinet which had the biggest energy consumption in a supermarket. We validated its energy conservation effect and carbon dioxide emission reduction effect. The cold temperature heat used for supercooling was manufactured by adsorption type refrigerator. The energy conservation effect of supercooling is about from 10 to 25% during the summertime and intermediate time. However there is no effect of supercooling in wintertime because outside temperature is low. At last, we found that when outside temperature is about 15°C or more, supercooling effect appears. In addition, since energy consumption of the refrigerated cabinet is influenced by inside enthalpy, we adjusted the inside air temperature and humidity by installing desiccant system and examined its effect.

1. INTRODUCTION

Since the nuclear disaster was caused by the Great East Japan Earthquake in 2011, Japanese energy generation system has been expected to prioritize safety and trustworthiness. Majority of power supply is depending on thermal power generation by fossil fuel because all nuclear power plants are out of operation. Taking into account, environmental issues such as global warming, energy saving strategy is very important. In Japanese industry, consumer sector's energy consumption increased 2.4 times from the 1970s and supermarkets consume the most energy in consumer sector (Katusta, 2014). To reduce the power consumption of supermarkets, many kinds of methods had been introduced all over Japan. For example, rearrange commodities to reduce thermal load, clean cold air outlet and turn off extra illumination (Himeji, 2011). Though these methods are easy to do, large energy saving effect can't be expected. It need mechanical method in order to reduce more power consumption. Therefore it is considered that it is important to install Energy management system (EMS) into the supermarket (NEDO, 2011).

From these backgrounds mentioned above, 1/15 scale model store which installed a novel environment-friendly dispersed power at the northern Kanto region 100 km from downtown Tokyo in Japan was built and EMS which controls not only electricity but also exhaust heat was developed. To reconstruct supermarket at this model store, we measured the power consumption of devices which is in the real supermarket and thermal environment. This supermarket is located in Isesaki-city, the northern Kanto region. From this measurement, the power consumption of refrigerated cabinet accounted for more than 60% of that of all electric systems. In addition, it accounted for 85 % during the summer (Hamamoto, 2014). Therefore our interests focused on the power consumption of refrigerated cabinets and it is expected that the reducing the power consumption of the refrigerated cabinet by condenser outlet supercooling has large energy saving effect.

2. 1/15 SCALE MODEL STORE DATA

2.1 The Information about Model Store

To investigate the effect of supercooling, 1/15 scale model store was used. The main apparatus in model store and schematic diagram of it are shown in Figure 1. This store set up gas engine whose output power is 9.9 kW. This gas engine generates electricity and makes exhaust heat of 80°C. Adsorption refrigerator can make 7°C cold water and desiccant material is regenerated by using this exhaust heat. Hot and cold water are used in many ways at this model store. In addition this store has solar panel and solar thermal collectors for reducing CO₂. PCM (thermal storage system) can maintain the temperature of cold water with 7°C. Heat pump air conditioner and desiccant system were used to make the model store's thermal environment. Specifications of four apparatuses are shown in Table 1.

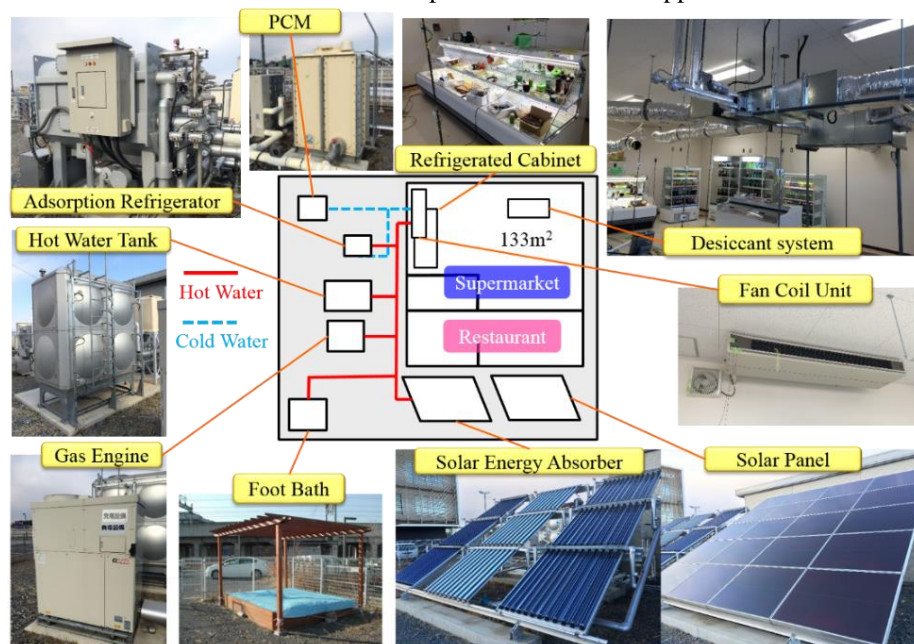

Figure 1: All Systems of 1/15 Model Store

Table 1: Specifications of Apparatuses in Model Store

(a) Gas Engine

Manufacture	YANMAR
Model	CP10VB1-SNB
Output Power	9.9 kW
Electric Voltage	100 V
Fuel	City Gas 12A
Hot Water	65°C→70°C (Max79°C)
Flow Rate	48.2 L/min
Heat Recovery Rate	53.3%

(b) Adsorption Refrigerator

Manufacture	MAYEKAWA	
Model	ADR-Z2012	
Refrigerant	H ₂ O	
Adsorbent Material	Zeolite	
Hot Water	Temperature	75°C→ 67.8°C
	Flow Rate	60 L/min
Cold Water	Temperature	13°C→7°C
	Flow Rate	43.3 L/min

(c) Desiccant System

Manufacture	MITSUBISHI PLASTICS	
Model	AQSOAE-0320H201-UW00	
Absorbent Material	Zeolite	
Regeneration Temperature	60°C	
	Before Processing	After Processing
	Air Volume	241 m ³ /hr
Air Temperature	25°C	44°C
Relative Humidity	60%	13.9%
Absolute Humidity	11.89 g/kg'	7.89 g/kg'

(d) Refrigerated Cabinet

Manufacture	Panasonic
Model (Cabinet)	CPS-EX2065
Model (Condensing Unit)	OCU-NR200F
Refrigerant	R404a
Temperature Setting	4°C
Evaporating Temperature	-10°C
Power Consumption	1.91 kW

2.2 Fundamental Experiment

In order to discuss on the effect of supercooling and desiccant system installing in detail, which kind of parameter affects the power consumption of refrigerated cabinet. Without modification to the refrigerated cabinet cycle, we run the refrigerated cabinet all day long on May 30th. We measured inside and outside thermal environment and the power consumption of the refrigerated cabinet every five minutes.

**Figure 2:** Result of Fundamental Experiment

Figure 2 shows two kinds of parameters which affect the power consumption. In Figure 2(a), the change pattern of power consumption resembles that of outside air temperature closely. The change pattern of inside air enthalpy is almost the same as that of energy consumption as shown in Figure 2(b). So, the result of this verification, the power consumption highly depended on the inside air enthalpy and the outside air temperature. In order to reduce the influence of outside air temperature, we installed the system which carries out supercooling, and checked the effect. And, in order to check the energy conservation effect of inside humidity control, the desiccant system is installed.

2.3 Supercooling Experiment

Experimental apparatus of supercooling experiment and p-h diagram are shown in Figure 3.

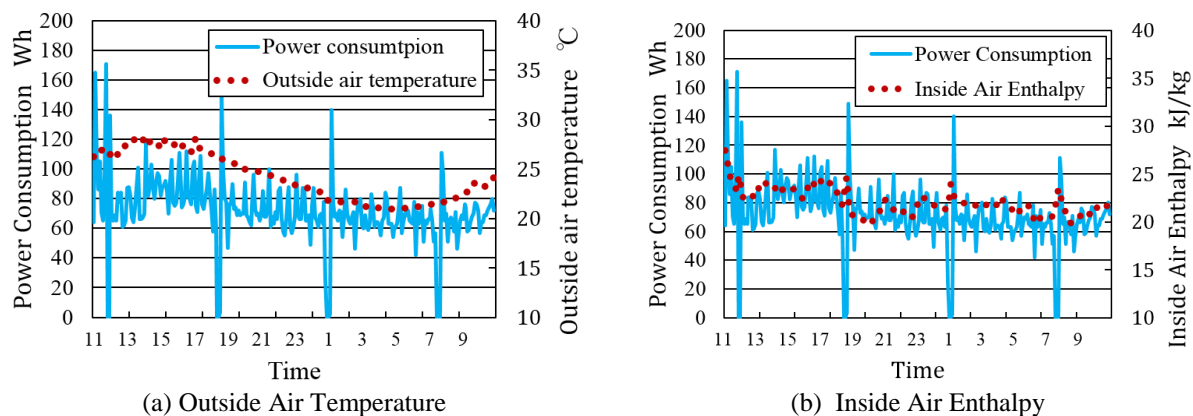
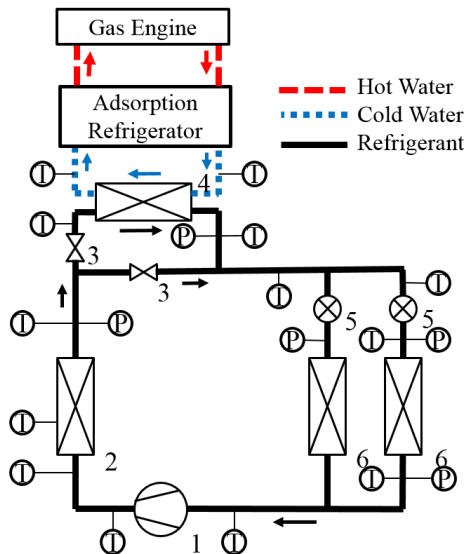

- 1: Compressor 2: Condenser 3,3': Valve
4: Heat Exchanger 5: Expansion Valve
6: Evaporator (Refrigerant: R404A)

(a) Experimental Apparatus of Supercooling Experiment

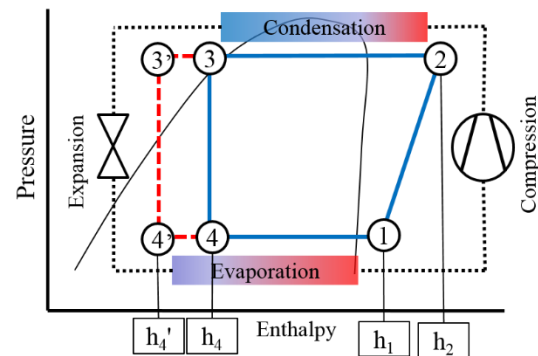

(b) p-h Diagram

Figure 3: Supercooling Experiment

As shown in Figure 3(a), the basic refrigeration cycle that consists of four kinds of components (compressor, condenser, expansion valve, and evaporator) is used. To investigate the effect of supercooling, a heat exchanger 4 installed after condenser 2. Cold water for supercooling is supplied by adsorption refrigerator using exhaust heat of gas engine. We can choose with and without supercooling condition by manipulating the valve 3 and 3'.

As shown in Figure 3(b), the effect of supercooling can be examined by next equation. Without supercooling, COP can be defined by using next equation (1)

$$\text{COP} = (h_1 - h_4) / (h_2 - h_1) \quad (1)$$

On the other hand, the COP with supercooling can be defined by using following equation (2)

$$\text{COP} = (h_1 - h_4') / (h_2 - h_1) \quad (2)$$

COP can be improve by supercooling effect, because the numerator of equation (2) became $(h_1 - h_4')$ higher than equation (1). The cooling capacity also should be increased by supercooling.

2.4 Energy Conservation by Dehumidification

According to the fundamental experiment, it was verified that the power consumption of the refrigerated cabinet highly depended on the inside air enthalpy. In Japan, during May to August it is very humid season as shown in Figure 4. Thus if we dehumidify inside air, it seems to be able to reduce the power consumption of the refrigerated cabinet. To dehumidify the inside air, we installed the desiccant system because it can remove the moisture using exhaust heat. And, supply air is cooled by cooling water which be made from adsorption refrigerator.

Desiccant system experiment had been done in August. The thermal environment of model store is shown in Table 2. We prepared two kinds of conditions. Thermal environment condition 1 is the target condition at the time of HP (Heat Pump) air conditioner use. And, the thermal environment condition 2 is the target condition at the time of desiccant system use. We determine the temperature of thermal environment condition 2 is a little higher than that of usual, because people can feel comfortable at low relative humidity condition.

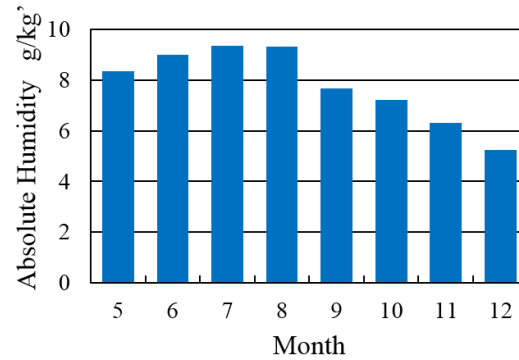

Figure 4: Monthly Absolute Humidity

Table 2: Thermal Environment

	Thermal Environment 1 (HP Air Conditioner)	Thermal Environment 2 (Desiccant Air Conditioner)
Temperature °C	25	28
Relative Humidity %	50	40

2.5 Experimental Methodology

We began to measure inside and outside thermal environment and many kinds of values about the refrigerated cabinet from July. According to fundamental experiment, we could know the outside air temperature and inside air enthalpy had effects to the power consumption of the refrigerated cabinet. Then we analyzed these data by seasonal, summer, autumn and winter, because temperature and humidity changed rapidly in one year. Table 3 shows the detail conditions of measurement.

Table 3: Detail conditions of Measurement

Operating Time	AM10:00~PM18:00	
Period	Summer : Jul ~ Aug Autumn : Sep ~ Oct Winter : Nov ~ Dec	
Objectives	Refrigerated Cabinet	Pressure Temperature
	Thermal Environment	Inside air temperature and relative humidity Outside air temperature and relative humidity
Measurement Items	Logging each moment value for every five minutes	

3. RESULTS AND DISCUSSION

3.1 The Influence of the Outside Air Temperature

The influence of the outside air temperature on condensation pressure and power consumption are shown in Figure 5, and each plots shows significant data at every hour.

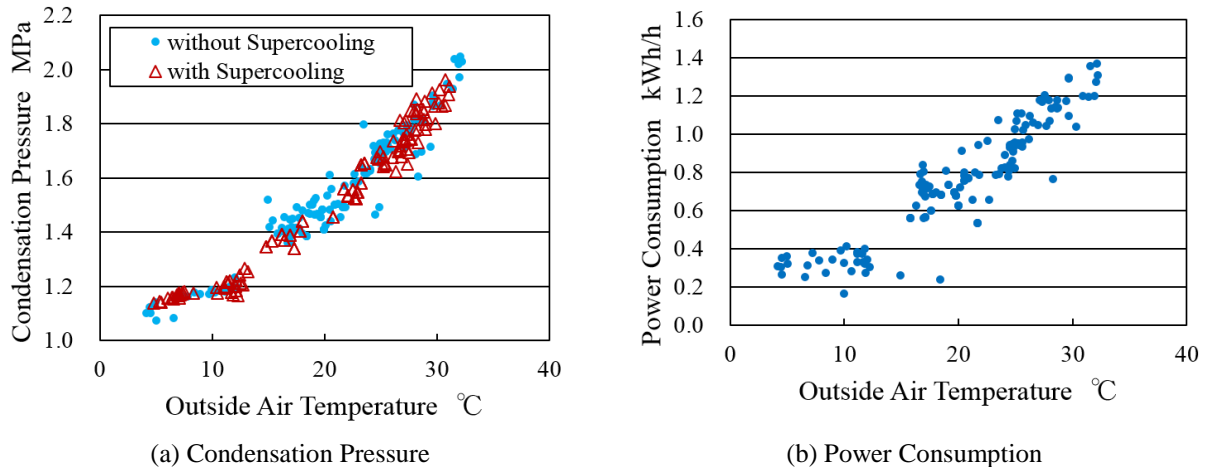

Figure 5: Relationship between Condensation Pressure and Power Consumption to Outside Air Temperature

The condensation pressure of refrigerated cabinet with outside air temperature is shown in Figure 5(a). The condensation pressure was affected by the outside air temperature regardless of supercooling. The power consumption of the compressor is increased with increasing condensation pressure. Therefore, it was recognized that the power consumption was directly correlated to the outside air temperature as shown in Figure 5(b).

3.2 The Results of the Supercooling

In Figure 6, it shows the power consumption results with and without supercooling experiments of each season. In every season, certain two days which had had similar outside thermal environment conditions were chosen and compared. Table 4 shows energy conservation effects and thermal environment conditions in each season.

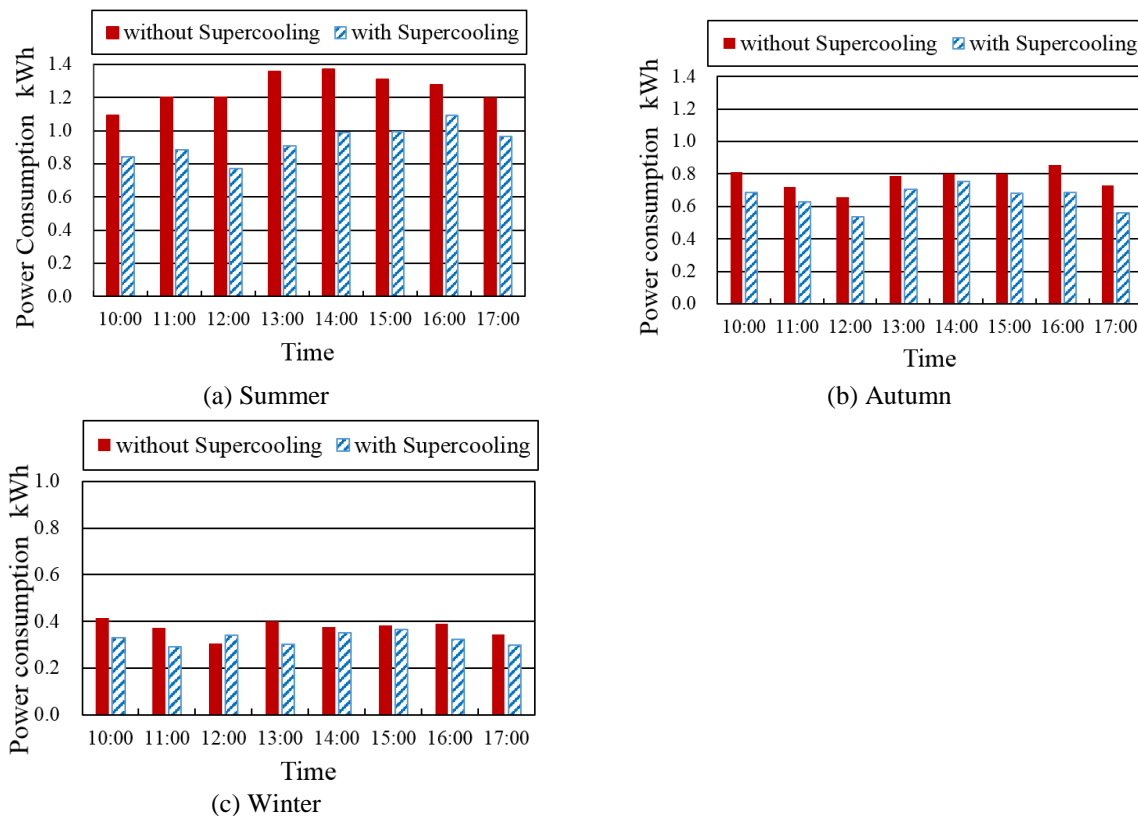
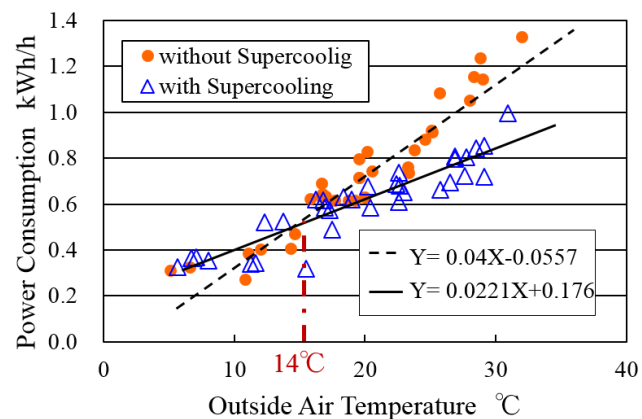

Figure 6: The Results of Supercooling Effect of Each Season

Table 4: Experimental Conditions and of Supercooling Effect

	supercooling	date	Outside Air Temperature °C	Inside Enthalpy kJ/kg	Degree of Supercooling °C	Reduction Rete %
Summer	N/A	30 th Jul	31	51	1.7	25.6
	A	31 st Jul	30	48	27.9	
Autumn	N/A	17 th Oct	20	41	1.6	15.1
	A	1 st Nov	19	41	15.1	
Winter	N/A	17 th Nov	11	36	0.2	6.3
	A	10 th Nov	12	35	11.2	

The power consumption of the refrigerated cabinet was reduced more than 25% in summer time. On the other hand, the reduction rate in autumn was 15% and in winter was only 6%. It was found that the largest supercooling effect was obtained in summer. Thus, it was considered that the outside air temperature is related to the effect of supercooling. In order to analyze these results, the relations between power consumption of the refrigerated cabinet and outside air temperature were shown in Figure 7. The plots should be categorized with and without supercooling and approximate line was calculated by least-squares method, then the point of intersection became 14°C.

**Figure 7:** The Effect of Supercooling

As shown in Figure 7, there was not so much difference in power consumption of both on outside air conditions lower than 14°C. However, when the outside temperature became 14°C or more, a significant difference appeared. According to the rise of outside air temperature, the supercooling effect also becomes large.

3.3 Results of Desiccant System Experiment

The power consumption of the refrigerated cabinet highly depended on the indoor air enthalpy. However, generally the indoor air temperature was maintained at target temperature throughout the year. That is the reason why our interest focused on the relation between absolute humidity and the power consumption of the refrigerated cabinet. Because we didn't have the device that controls the outside thermal environment conditions, these experiments were carried out under almost the same outside thermal environment condition.

From Figure 8(a), the power consumption was directly proportional to the inside air absolute humidity and it was confirmed that dehumidification is very effective for energy saving. The plots in Figure 8(a) show the power consumption of the refrigerated cabinet at every hour and these data were taken at the outside temperature 20°C in autumn. Figure 8(b) shows the result of energy consumption by desiccant system and the daily amount of power consumption of the refrigerated cabinet. This experiment was achieved on July 30th and August 3rd 2013 because the outside air enthalpy of these days was almost same. According to Figure 8(b), the power consumption of the refrigerated cabinet was reduced about 11% in the daytime. By the Building Standards Act, the relative humidity in the buildings should be kept at 40% or over. The temperature of our supermarket is set at about 23°C through the year. When the thermal condition in the room is 23°C and 40%RH, absolute humidity is about 7 g/kg'. Therefore, when the absolute humidity in the daytime is more than 7 g/kg', it is identified that the energy saving with using desiccant system is very effective. As shown in Figure 4, because the average relative humidity from May to August is 7 g/kg' or more. Using desiccant system can achieve large energy saving effect.

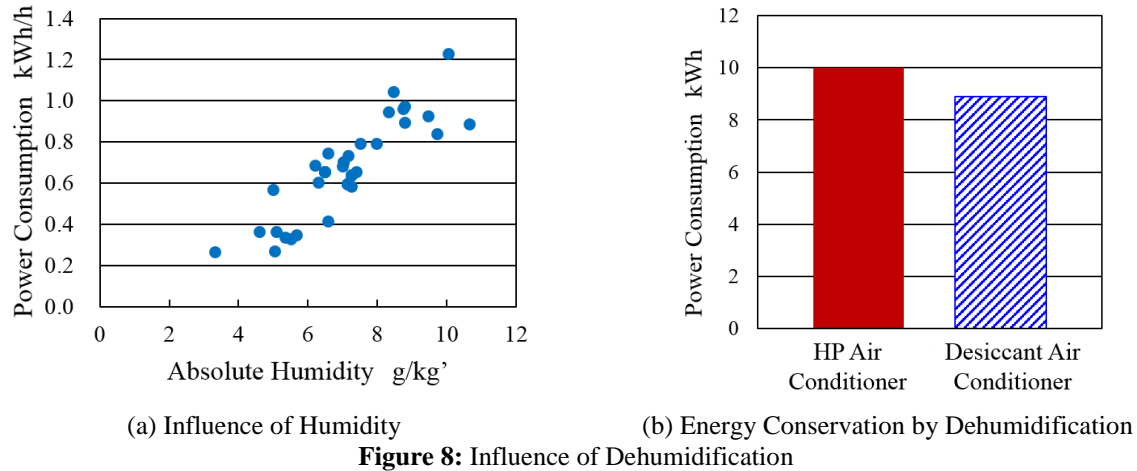

3.4 The Reduction of CO₂ Emission

The decrease amount of refrigerated cabinet's power consumption by supercooling and dehumidification using desiccant system was clarified. Then the reduction of CO₂ emission is discussed in the following section. The apparatuses shown in Table 5 was included in the calculation of CO₂ emission in this experiment.

Table 5: Apparatuses used by Experiment

Apparatus		Supercooling Experiment		Dehumidification Experiment	
		Without Supercooling	With Supercooling	HP Air Conditioner	Desiccant Air Conditioner
Refrigerated Cabinet		○	○	○	○
Supercooling		—	○	—	—
Refrigeration Apparatus	Adsorption Refrigerator	—	○	—	○
	Cooling Tower	—	○	—	○
HP Air Conditioner		—	—	○	○
Desiccant Air Conditioner		—	—	—	○
Pump		—	○	○	○

And also the specific energy consumption in model store was made the same with that of real store by using the floor area. The seasonal specific energy consumption of model store and real store was shown in table 6. In order to calculate the specific energy consumption, we used refrigerated cabinet's power consumption which doesn't use supercooling.

Table 6: Specific Energy Consumption

	Floor Area m ²	Specific Energy Consumption kWh/m ²		
		Summer	Intermediate Season	Winter
Real Store	2754	0.63	0.37	0.33
Model Store	77.7	0.13	0.08	0.04

Basically the apparatuses in model store used the electricity made by gas engine but the apparatuses using 200V power source such as pump, adsorption refrigerator and refrigerated cabinet used that of grid power. That is, two types of emission coefficient were needed. We used 0.55[kg-CO₂/kWh] for grid power and 0.63[kg-CO₂/kWh] for gas engine to calculate. In addition the output power of pump was too much for the model store. There for, CO₂ emission was calculated by using twenty percent of pump's electricity. The CO₂ emission of supercooling experiment discussed in section 3.2 is shown in table 7.

Table 7: CO₂ Emission of Supercooling

	Supercooling	Amount of CO ₂ Emissions kg- CO ₂				Reduction of CO ₂ Emission kg
		Refrigerated Cabinet	Refrigeration Apparatus	Pump	Sum Total	
Summer	—	31.1	—	—	31.1	—
	○	23.0	7.3	1.0	31.4	-0.3
Intermediate Season	—	18.5	—	—	18.5	—
	○	15.6	7.3	1.0	23.9	-5.4
Winter	—	16.1	—	—	16.1	—
	○	15.0	7.3	1.0	21.7	-7.2

From table 7, CO₂ emission of supercooling experiment was higher than that of without supercooling experiment in all season. Because the power consumption of refrigeration apparatus was higher than the reduction of refrigerated cabinet's power consumption. The CO₂ reduction by applying supercooling is not effective because amount of CO₂ emission from refrigeration apparatus is large. If, however, there are more ways to use cold heat from refrigeration apparatus such as fan coil unit, supercooling can be one of effective measures. Taking into account not only supercooling effect but also air conditioner, table 8 shows the comparison of CO₂ emission between operating with or without exhaust heat. We obtained this data at summertime when the outside air temperature was 31°C and preset temperature of fan coil unit was the same as HP air conditioner.

Table 8: Comparison of CO₂ Emission with or without exhaust heat

Operation Method	Amount of CO ₂ Emissions kg- CO ₂							Reduction of CO ₂ Emission kg
	Super cooling	Refrigerated Cabinet	Refrigeration Apparatus	Pump	HP Air Conditioner	Fan Coil Unit	Sum Total	
Without Exhaust Heat	—	31.1	—	—	13.6	—	44.7	—
With Exhaust Heat	○	23.0	7.3	1.0	—	0.5	31.8	12.9

Therefore, it enables us to reduce nearly 13 kg-CO₂ emissions at supermarket by utilizing exhaust heat, which is worth about third part of all. We found that using supercooling and fan coil unit at the same time could lead to reduce large percent of CO₂ emissions as a whole. Finally, we examined the variation of CO₂ emissions by dehumidification using desiccant air conditioner. The following is the amount of CO₂ emissions when we used desiccant air conditioner discussed in section 3.3.

Table 9: CO₂ reduction effect of Desiccant System

	Amount of CO ₂ Emissions kg- CO ₂						Reduction of CO ₂ Emission kg
	Refrigerated Cabinet	Refrigeration Apparatus	Pump	HP Air Conditioner	Desiccant Air Conditioner	Sum Total	
HP Air Conditioner	31.1	—	—	13.6	—	44.6	—
Desiccant Air Conditioner	27.6	7.3	1.2	4.4	1.6	42.1	2.5

Table 9 shows that using desiccant air conditioner decreases CO₂ emissions. It was found that we could decrease the CO₂ emissions without supercooling. Therefore, we can expect the additional energy saving benefits by combining supercooling and desiccant air conditioner.

4. CONCLUSION

- The outside temperature and inside absolute humidity had influences to the power consumption of the refrigerated cabinet in scale model store.
- When the outside air temperature was higher than 14 °C, the power consumption of refrigerated cabinet should be decreased by supercooling.
- The dehumidification using desiccant was effective for energy conservation at the high humidity season such as from May to August.
- It was difficult to reduce CO₂ emission by only supercooling, but combining with another exhaust utilization apparatus, it was able to reduce 30% of CO₂ emissions in summertime.

NOMENCLATURE

h	enthalpy of refrigerant	(kJ/kg)
P	pressure of refrigerant	(MPa)
T	temperature of refrigerant	(°C)

REFERENCES

Katusta, M., 2014, Recent Development in Heat pump Technology in Japan, *11th IEA Heat Pump Conference 2014*, p.1-2

Hamamoto, R., 2014, Energy Conservation of Commercial Refrigerated Cabinets in Supermarkets –Focusing on the Influence of Sub Cooling after Condenser of Cabinets-, *11th IEA Heat Pump Conference 2014*, p.2-5

Himei, H., 2011, The present conditions investigation into power saving measures in the supermarket and description of the power saving technique of refrigeration facilities, *SERC Discussion Paper*, Tokyo, P.5-20

New Energy and industrial Technology Development Organization (NEDO), 2011, Renewable energy white paper, Morikita Publishing Co., Ltd., Tokyo, P.631-64

ACKNOWLEDGEMENT

This research is supported financially by the ministry of environment, Government of Japan.