

2014

Reducing Display Bottle Cooler Energy Consumption Using PCM As Active Thermal Storage

Marcel van Beek

Re/genT BV, Netherlands, The, marcel.van.beek@re-gent.nl

Hans de Jong

Re/genT BV, Netherlands, The, hans.de.jong@re-gent.nl

Follow this and additional works at: <http://docs.lib.purdue.edu/iracc>

Beek, Marcel van and Jong, Hans de, "Reducing Display Bottle Cooler Energy Consumption Using PCM As Active Thermal Storage" (2014). *International Refrigeration and Air Conditioning Conference*. Paper 1494.
<http://docs.lib.purdue.edu/iracc/1494>

This document has been made available through Purdue e-Pubs, a service of the Purdue University Libraries. Please contact epubs@purdue.edu for additional information.

Complete proceedings may be acquired in print and on CD-ROM directly from the Ray W. Herrick Laboratories at <https://engineering.purdue.edu/Herrick/Events/orderlit.html>

REDUCING DISPLAY BOTTLE COOLER ENERGY CONSUMPTION USING PCM AS ACTIVE THERMAL STORAGE

M. V. BEEK¹, H. D. JONG¹

¹ Re/genT BV

Helmond, The Netherlands

Tel: +31(0)492 476365, e-mail: marcel.van.beek@re-gent.nl

ABSTRACT

The final results of an analytical and experimental study in reducing the energy consumption of a display bottle cooler using Phase Change Material (PCM) as an active thermal storage are presented. The objective of the study was to design and build a 350 dm³ glass door bottle cooler having an appliance energy consumption reduction of over 75% compared to state of the art bottle coolers (2010 figures).

Calculation results show that active thermal storage using PCM can be effectively applied to store and release cold on demand in small cooling appliances subjected to high peak loading. It is shown that by using the thermal storage smaller cooling systems can be applied, resulting in system operation at reduced temperature lift and thereby at higher efficiency.

A validated control solution, including a sensor which detects the state of the PCM, is presented. It is shown that for a bottle cooler, optimum performance results for a dual forced air evaporator system, with one evaporator embedded in the PCM and the other in direct contact with the air stream. To obtain minimum product cooling times a different refrigerant flow path through the evaporators is required between the main modes of operation (i.e. half reload recovery and steady state). The optimum position of the PCM embedded evaporator is upstream of the main evaporator with respect to the airflow.

A design of a display bottle cooler applying standard heat load reduction measures in combination with PCM as active thermal storage is presented. The design is based on using a 5.19 cm³ R-600a compressor in combination with forced air heat exchangers. The integration of the PCM in the appliance cooling system and the control aspects resulting are discussed in detail. Experimental test results of a demonstrator cabinet at an ambient of 25 °C and 60 %Rh show that a 350 dm³ glass door bottle cooler having a total energy consumption (TEC, including half reload recovery) of < 1 kWh/24 h can be built while achieving a half reload recovery within 16 h at an ambient of 32 °C and 65 %Rh.

1. INTRODUCTION

This paper presents a summary of the work undertaken under the 7th European Framework Programme project with acronym iCool regarding the development of a highly efficient bottle cooler making active use of Phase Change Material (PCM). Efforts to improve the efficiency and performance of a cooling appliance by using PCM are pursued before. These efforts include refrigerators fitted with PCM to the condenser to reduce the condensation temperature during compressor on-time (Cheng et al., 2011), refrigerators fitted with PCM inside the cold compartment to increase the thermal mass and to minimize product temperature fluctuation (Gin et al., 2009) and refrigerators fitted with PCM to the evaporator to increase the system efficiency and to overcome temporarily power loss (Azzouz et al., 2009, Khan and Afroz, 2013). All these efforts indicated the main advantages of using PCM, namely the possibility to create a thermal buffer releasing and absorbing energy when required. The main advantage of the design discussed here is in the integration of the PCM within the cooling circuit (Figure 1) and the possibility to increase appliance cooling power on demand. Next to this, the PCM is applied such that the thermal capacity of the evaporator increases, thereby increasing the evaporation temperature and reducing the temperature lift of the

cooling system during compressor operation. The design is based on operating at minimum temperature lift, through applying a relatively small compressor, just coping with the time averaged cooling demand at the warmest design temperature, and using PCM to meet the high cooling demand required during cooling down of the product.

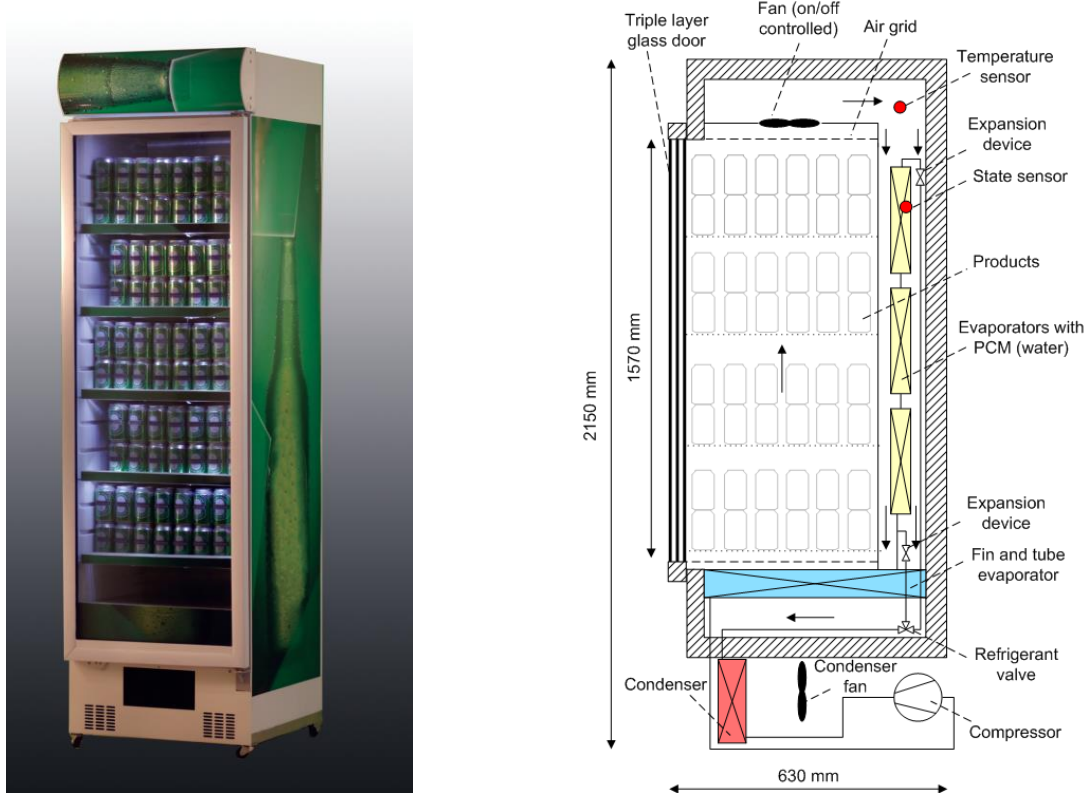

Figure 1: Picture of final iCool demonstrator (left) and system principle sketch (right) in which the positioning of the PCM casings inside the air duct, the positioning of the fin and tube evaporator and the direction of the air flow is shown.

The project target was to develop a 350 dm³ glass door bottle cooler having an energy consumption reduction of over 75% compared to state of the art bottle coolers while meeting the HRR specification at 32 °C ambient. Benchmarking showed that an average bottle cooler (2010 figures) has an appliance volume of 386 dm³ and a total appliance energy consumption (TEC), including half reload recovery and appliance lighting during business hours, of TEC = 5.7 kWh/24h. This is in good agreement with the latest results of the LOT 12 study (Joint Research Centre, 2014) which shows an average TEC of 6.0 kWh/24h for a 350 dm³ glass door bottle cooler. Within the present study a standard glass door beverage cooler, having a storage volume of V = 351 dm³ and a measured TEC of 3.96 kWh/24h was selected as practical benchmark and the energy consumption test (HE, 2013) is used to define the TEC. This test, performed at an ambient temperature of 25 °C, relative humidity of 60 %Rh and an average product (0.33 dm³ can) temperature of < 2.5 °C, includes internal and canopy lighting during business hours and accounts for executing 110 half reload recoveries each year. A half reload recovery (HRR) exists out of replacement of half of the products within the refrigerated volume by products at ambient temperature and measurement of the time and energy needed to cool down the load to a specified temperature (e.g. warmest product < 6 °C and average product ≤ 2.5 °C).

To reduce the TEC from 4 to below 1 kWh/24h, while meeting the half reload recovery (HRR) specification of 16 h at an ambient of 32 °C, a large reduction in appliance heat load and increase in the efficiency of the cooling system is required. In the following sections first the heat reducing and efficiency improving measures applied are discussed. Hereafter, the iCool principle, applied as a last energy improving measure, is discussed in detail. Hereafter, the results of practical testing performed on the iCool demonstrator appliance are presented followed by the discussions and conclusions.

2. APPLIANCE DESIGN

Within the project the focus was on designing an appliance with minimum change in volume occupation compared to a standard beverage cooler (i.e. practical benchmark). Therefore, it was decided to increase the thermal resistance of the appliance with the ambient by fitting in total 9 vacuum insulated panels (Va-Q-VIP with a size of 600 * 500 * 20 mm and a specified heat transfer coefficient of $U = 0.22 \text{ Wm}^{-2}\text{K}^{-1}$) into the PUR foamed, 47 mm thick, sides and back panel of the appliance. Next to this a triple layer krypton filled glass door (Everclear, 1570 * 550 * 32 mm, overall heat transfer value (UA), including door frame and seal of $UA = 1.1 \text{ WK}^{-1}$) was fitted. Reversed heat load measurements of the appliance showed that by using these components a reduction in the overall cabinet heat transfer value from $UA = 4.2$ (for the practical benchmark) to 2.45 WK^{-1} has been obtained. The appliance heat load is also affected by the sealing of the door, the efficiency of the internal fan and the internal lighting applied. To minimize these effects, a high efficiency fan (EBM Papst Aci 4420 HH), having a power consumption of 6 W and standard LED lighting (Flexible LED strip LP12W210CW65, Velleman NV) of 7.2 W internal and 2.8 W in the canopy were fitted. The resulting appliance heat load and its distribution is shown in Figure 2. For comparison also the heat load distribution of the practical benchmark is shown.

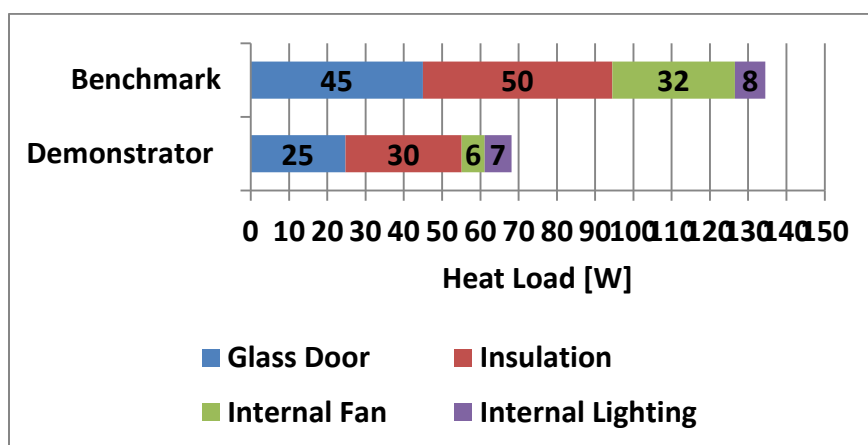

Figure 2: Heat load distribution of the iCool demonstrator and the practical benchmark.

3. COOLING SYSTEM DESIGN

Following Carnot, the efficiency of a cooling system is directly related to the temperature difference between the evaporator (source) and the condenser (sink). The smaller the temperature lift, the less work required and the higher the efficiency of the cooling system. The temperature difference required in a forced air cooled glass door bottle cooler depends on the appliance heat load, the thermal resistances between the internal air and the evaporator, between the internal air and the product and between the condenser and the ambient. To obtain relatively high evaporation temperatures, while maintaining all products within 1 and 6 °C at an average temperature of 2.5 °C (HE, 2013), it is critical to have small product temperature spread. Due to this, and to have the lowest possible thermal resistance between the product and the cold air flowing through the cabinet, the design is based on uniform airflow throughout the product section, see Figure 1. To keep the temperature difference between the evaporating refrigerant and the internal air small for acceptable pressure drop ($< 10 \text{ Pa}$), a fin and tube evaporator filling the complete cross sectional area of the cold space (500 * 430 * 50 mm and a fin pitch of 4 mm) was fitted. Measurement of evaporator performance, using an evaporator calorimeter, resulted in an overall heat transfer value of $UA = 40 \text{ WK}^{-1}$ (based on the logarithmic temperature difference between the refrigerant and the air) at an air flow rate of $100 \text{ m}^3\text{h}^{-1}$, a refrigerant evaporation temperature of -5.0 °C , refrigerant superheating of 5.2 K and refrigerant inlet quality of $x = 0.232$. This evaporator is connected in series with the PCM based evaporator, see Section 4. To obtain maximum heat transfer (maximum temperature difference) between the internal air and the PCM evaporator, the PCM evaporator is fitted upstream with respect to the airflow to the fin and tube evaporator. As condenser, a compact fin and tube heat exchanger (LU-VE FCE46) was applied in combination with a high efficiency axial fan (Papst iQ2 612-310252 fitted with a 172 mm blade having an angle of 28°) having an energy consumption of 3.2 W. To further enhance the efficiency of the cooling system the capillary tube was soldered against the suction line, thereby creating a suction line heat exchanger.

Manufacturer data (SECOP, ACC, and EMBRACO) showed that the highest efficiency compressors available within the desired cooling regime (100 to 300 W) are low back pressure (LBP) R-600a compressors, which are typically applied in domestic refrigerators. As no high starting torque compressors of similar capacity and efficiency could be found, no effort was made to reduce the cycle losses of the system through applying a liquid line closing valve.

The iCool principle is based on minimizing the temperature lift of the cooling system through applying a small compressor just coping with the time averaged heat load at the warmest ambient condition. Thereby resulting in relatively long operating periods and small cyclic temperature variations (i.e. a cyclic variation in evaporation temperature of $< 1.0\text{ }^{\circ}\text{C}$ resulted for the demonstrator operating at an ambient of $25\text{ }^{\circ}\text{C}$). Therefore, only marginal additional reduction of appliance TEC is expected from applying a variable capacity compressor in combination with using active PCM compared to using a fixed capacity compressor with active PCM. Due to this and because manufacturer data of SECOP and EMBRACO, showed that the efficiency of a variable speed compressor is typically lower than the efficiency of the best in class low back pressure compressors without capacity modulation, the study performed focused on the use of fixed capacity compressors only. After consulting the manufacturer, a high efficiency 5.19 cm^3 R-600a compressor (Embraco EMD26CLT, COP = 1.88 at ASHRAE LBP) was selected. Calorimetric measurements of compressor performance, using a compressor calorimeter with a secondary fluid calorimeter on the suction side (method A, EN1377-1) in combination with a refrigerant flow meter in the liquid line (method D, EN1377-1), showed a measured COP of 3.8 at the design condition of the cooling system. (ambient at $25\text{ }^{\circ}\text{C}$, evaporation temperature of $-2.5\text{ }^{\circ}\text{C}$, condensation temperature of $33\text{ }^{\circ}\text{C}$, subcooling of $31\text{ }^{\circ}\text{C}$, a superheating of $0\text{ }^{\circ}\text{C}$ and an suction gas temperature of $25\text{ }^{\circ}\text{C}$). This in combination with the suction gas heat exchanger, assumed thermal efficiency of 60%, results in a cycle COP of 4.2 for the cooling system of the iCooler. This is approximately 2.5 times larger than the cycle COP of the benchmark cooler.

4. PCM EVAPORATOR

The main purpose of the PCM is to create a cold storage to increase system cooling capacity during HRR, thereby making it possible to apply a relatively small compressor, while meeting the HRR requirement of cooling the product within 16 h. It is commonly known that with using PCM in cooling, one of the main difficulties is in the heat resistance between the PCM and the space to be cooled and between the PCM and the cooling circuit. Within

iCool multiple design concepts were considered. However, within this paper only the final design, based on a plate evaporator integrated inside a PCM casing, is presented, see Figure 3 and Figure 1.

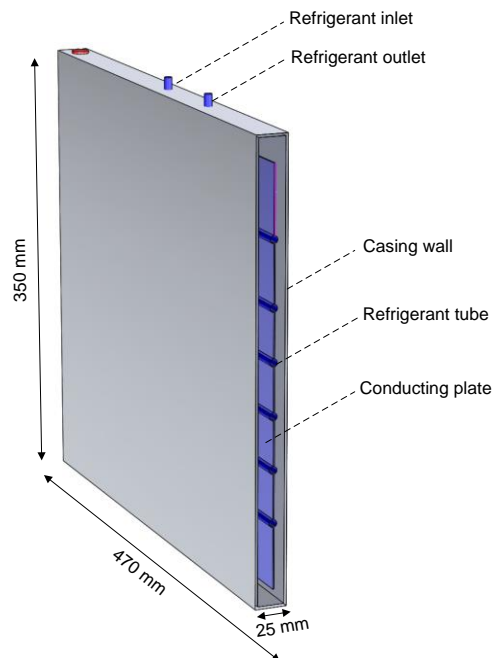

Figure 3: Section view of PCM casing with plate evaporator.

The main advantages of this design are the small distance between the cold plate and the casing wall and the unidirectional solidification and melting of the PCM (i.e. melting from the casing wall inward and solidification from the evaporator plate outward). In the demonstrator, the thickness of the casing is 25 mm and the maximum thickness of the PCM is 10 mm. In the design the main thermal resistance between the evaporating refrigerant and the PCM to be frozen results from the thermal conductivity and the thickness of the PCM layer. The PCM is kept in partly unfrozen state, see Section 5. Therefore during compressor activation, the PCM is frozen with relatively small thermal resistance and hence small temperature difference between the evaporator and the PCM phase change temperature. For example, when using water / ice as PCM, a maximum thermal resistance in the order of $0.005\text{ Km}^2\text{K}^{-1}$ results for the freezing of the PCM close to the casing wall (which is the last layer being frozen). This is an order of magnitude smaller than the thermal resistance between the air passing over the casing and the casing wall, for which a thermal resistance of $0.04\text{ Km}^2\text{K}^{-1}$ is calculated after optimization of the duct size. Due to this difference

in thermal resistance, applying PCM will result in an increase in heat transfer and evaporation temperature during the compressor on cycle in comparison to a configuration without applying PCM. Thereby further reducing the temperature lift of the cooling system and the overall appliance efficiency. A disadvantage of this specific design, is that for proper functionality a PCM having maximum specific volume in the solid state must be applied (i.e. for a paraffin based PCM an air layer will result in between the casing wall and the PCM frozen onto the cold plate, thereby resulting in large thermal resistance between the internal air and the PCM).

5. CONTROL

A bottle cooler has two main modes of operation; namely cooling down of the product (represented here by half reload recovery, HRR) and steady state operation. To obtain maximum cooling capacity during HRR, the system is designed such that the refrigerant flow path varies between the two modes of operation. During steady state, the refrigerant is flowing through both evaporators, hence cooling the product and freezing the PCM. During HRR the PCM evaporator is bypassed (switching of the refrigerant valve) to maximize the refrigeration capacity available for cooling the product (Figure 4).

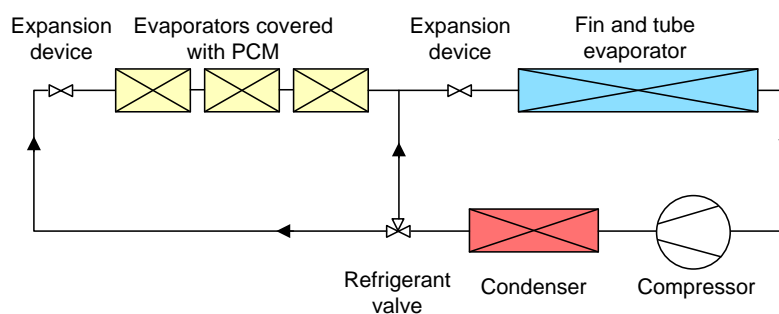

Figure 4: Control principle: Showing the refrigerant valve which switches the flow path of the refrigerant between flowing through the PCM and the fin and tube evaporator during steady state and only flowing through the fin and tube evaporator during HRR.

During steady state the refrigeration system should solidify the PCM without yielding too low internal air temperatures. Within the project a control strategy is developed in which, during steady state, the cooling system is driven by the state of the PCM (between 80 and 95% frozen) and the internal temperature is regulated through air flow control (on / off). Within the project various PCM state measurement principles were considered. Of these options, electrical conductivity measurement was selected due to the ability to measure the actual state of the PCM (frozen fraction) within the casing through detection of the position of the liquid / solid interface. Due to the unidirectional phase change and the positioning of the PCM casings within the air stream it is possible to regulate the state of the PCM using a single sensor fitted in the top PCM casing. The actual design of the state sensor is outside the scope of this paper.

6. MODELLING

For modelling of the iCool bottle cooler principle, an appliance simulation model was set-up in Matlab R2011b using the refrigerant property program REFPROP 9.1 (Lemmon et al, 2013). The model, based on a quasi-static approach, describes the performance of the iCool bottle cooler in the time domain and predicts the cooling performance and the overall energy consumption of the appliance. The model starts in HRR mode, during which the lighting is off. The steady state operation, including business / non business operation, is accessed at reaching the compressor cut off temperature for the first time. The model, see Table 1 for the input parameters, calculates the can temperature (lumped mass approach) of the cooling and storage load, the air temperature inside the cooled volume, the evaporator temperature and the condenser temperature at each time step. Next to this, the model calculates the energy consumption of the compressor from the operating conditions of the cooling system and using compressor polynomials (EN12900 polynomial) derived from fitting of manufacturer data. The model also determines the energy consumption and possible heat load of the auxiliaries based on the state of the appliance (compressor on / off) and the state of operation (business / non business). The model includes the change in the refrigerant circuitry after completion of the HRR as discussed in Section 5. The model is based on a heat balance between the

temperature of the internal air, the evaporator temperature, PCM temperature, can temperatures, appliance heat load (i.e. through the glass door + insulation and the auxiliaries) and the cooling capacity of the compressor. In the model the interaction between the internal air and the evaporator, between the PCM and the air and/or the evaporator and between the air and/or evaporator and the cans is included by an estimated overall heat transfer value for the specific heat exchange processes. These values were derived from practical testing of the components and the estimation of the heat transfer between the cans and the internal air from measurements performed on prototype appliances. These analyses are outside the scope of this paper.

Using the model, calculations were performed for a compressor range in between 2.1 cm³, which is the limit to cope with the time averaged heat load at an ambient of 32 °C, and 6 cm³. All calculations were based on equal compressor efficiency, which was derived by proportional scaling of the compressor polynomial of a high efficiency commercially available 3 cm³ compressor using R-600a as refrigerant (SECOP HXD30AA, COP of 1.71 at ASHRAE LBP). Calculations were performed applying a PCM with a phase change temperature at just above the steady state operating temperature (Rubitherm RT4, with a phase change temperature range between 2 and 4 °C), using a PCM with a phase change temperature of 0 °C (water) and without applying PCM. In the latter case the PCM based evaporator is evaluated as an additional refrigerant air heat exchanger with an UA value of 25 WK⁻¹ and the refrigerant is continuously flowing through both evaporators (i.e. valve position continuously in steady state mode).

Table 1: Input parameters of the simulation model

UA between condenser and the ambient	[WK ⁻¹]	37	Specific heat product	[Jkg ⁻¹ K ⁻¹]	3921
UA between the fin and tube evaporator and the internal air	[WK ⁻¹]	40	Total number of 0.33 dm ³ cans	[no.]	420
UA between the PCM and the internal air	[WK ⁻¹]	25	Number of cans during half reload	[no.]	210
UA between the evaporator and the PCM during steady state operation	[WK ⁻¹]	200 ice; 20 PCM +4 °C	Initial temperature of reload product	[°C]	32
UA between the evaporator and the PCM during HRR	[WK ⁻¹]	0.01	Pull down temperature	[°C]	2.5 & 6
UA between the internal air and the product	[WK ⁻¹]	45	Thermostat on/off	[°C]	2.5 /1.5
UA between the internal air and the ambient	[WK ⁻¹]	2.5	Evaporator fan power consumption	[W]	6
PCM phase change temperature	[°C]	4 & 0	Condenser fan input power	[W]	4
PCM quantity	[kg]	8.7	Lighting power	[W]	10
Ambient temperature	[°C]	32	Heat load due to the internal lighting	[W]	6
Refrigerant subcooling temperature	[°C]	30	Heat load due to the evaporator fan	[W]	6
Refrigerant superheating temperature	[K]	2	Business hours (lighting on)	[h/24h]	8
Mass product	[kg/can]	0.36			

The results (Figure 5 and 6) show that the influence of the PCM on the HRR reduces with increasing compressor capacity and that the half reload recovery time (HRRT) is shortest when water is applied as PCM. The results (Figure 7) also show that the total energy consumption, as expected, is lowest for the smallest capacity compressor (i.e. smallest temperature lift) and increases with increasing compressor capacity. Next, it is seen that applying a PCM with a phase change temperature above the steady state operating temperature is not beneficial for the appliance total energy consumption. This results from the fact that in this case only limited heat is absorbed by the PCM during steady state and that therefore the PCM mainly acts as an additional thermal resistance between the evaporator and the internal air. Note that for the +4 °C PCM, due to the poor thermal conductivity ($k = 0.2 \text{ Wm}^{-1}\text{K}^{-1}$), a relatively low overall heat transfer value ($UA = 20 \text{ WK}^{-1}$) results between the PCM and the evaporator. For the 0 °C PCM (water), a much higher heat transfer value ($UA = 200 \text{ WK}^{-1}$) is estimated between the PCM and the evaporator (section 4). This will result in operation at increased evaporation temperature, reduced temperature lift

and therefore at higher appliance efficiency compared to the configuration without PCM. This is shown in Figure 7 by the lowest TEC resulting for the PCM with a phase change temperature of 0 °C and the reduction in TEC with increasing PCM mass in Figure 8 and Figure 9.

The relatively low TEC values resulting for the 4 °C PCM at small compressor size ($< 3 \text{ cm}^3$) seem to contradict with this. In the model and in the actual appliance, the HHR mode, during which the appliance lighting is turned off, is only completed after reaching an internal air temperature below 1.5 °C. Therefore business non business operation is only accessed after over 50 h for these configurations (see also Figure 5 which shows extremely long HRRT for a compressor size $< 3 \text{ cm}^3$ in combination with the + 4 °C PCM). This, due to short time period with appliance lighting activated, results in the relatively low TEC values for these configurations. Note that these configurations do not meet the HRR requirement of cooling the load within 16 h.

The influence of the PCM is strongly related to the desired cooling temperature. For cooling to a product temperature of 2.5 °C (Figure 5) applying the 0 °C PCM results in a reduction in the cooling time while applying the 4 °C PCM delays the cooling time in comparison to the configuration without PCM. For cooling to a product temperature of 6 °C (Figure 6) both PCM types result in a reduction of the cooling time.

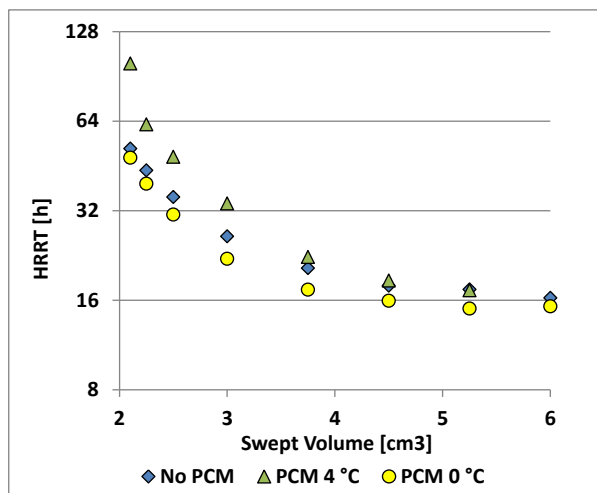

Figure 5: HRRT for various compressor sizes at an ambient of 32 °C and defining the end of HRR at a product temperature of 2.5 °C.

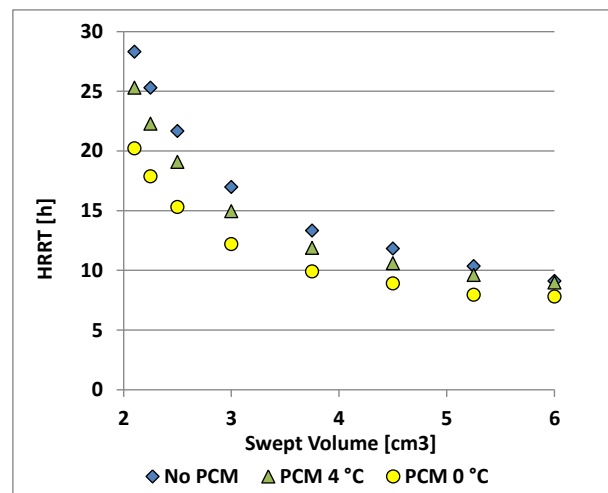

Figure 6: Cooling time to a product temperature of 6 °C for various compressor sizes at an ambient of 32 °C

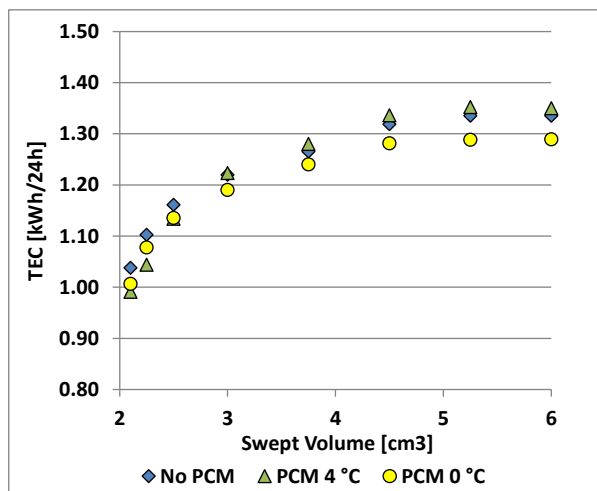

Figure 7: TEC for various compressor sizes at an ambient of 32 °C.

The calculations based on completion of the HRR at a product temperature of 2.5 °C (Figure 5) show that for the maximum specified HRRT of 16 h, the compressor swept volume can be reduced from 6 to 4.5 cm³. This compressor size reduction corresponds to an energy consumption reduction of approximately 4% (Figure 7). The calculations also show that applying PCM becomes more beneficial if warmer product temperatures are acceptable for definition of the HRR. For example, when specifying the end of the HRR at a product temperature of 6 °C (Figure 6), the compressor swept volume can be reduced from 3.24 to 2.43 cm³ by applying active PCM. This compressor size reduction corresponds to a reduction in appliance TEC of approximately 9%.

The influence of the PCM is, next to the phase change temperature, strongly affected by the mass of PCM (Figure 8) and the heat transfer between the PCM and the internal air (Figure 9).

For given heat transfer the complete PCM is just melted at completion of the HRR at a specific PCM mass (approximately 10 kg in Figure 8). Further increasing the mass of PCM results in a partly melted PCM at the end of the HRR and has no further effect (constant temperature) on the heat exchange between the PCM and the internal air and on the resulting HRRT.

Figure 8 indicates that the appliance TEC reduces with increasing quantity of PCM. This effect is strongly related to the relatively high overall heat transfer between the PCM to be frozen and the evaporator, which is a constant ($UA = 200 \text{ WK}^{-1}$) in the model. In an actual system, e.g. design of Figure 4, this heat resistance either increases proportional to the PCM mass (i.e. layer thickness) or much larger heat exchangers are resulting (i.e. proportional scaling of the heat transfer area with the mass of PCM).

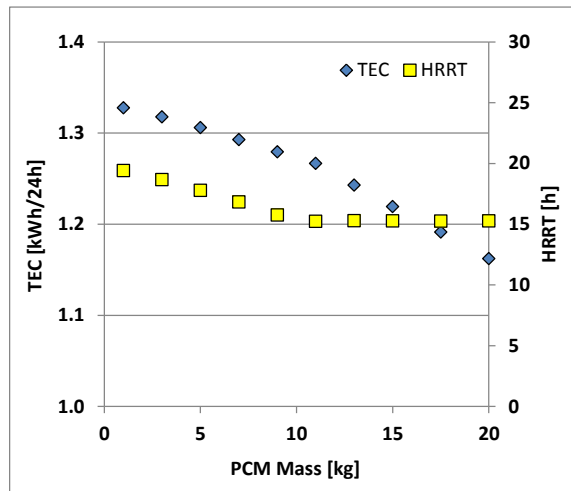

Figure 8: TEC and HRRT for increasing PCM mass. “PCM of 0 °C, compressor of 4.5 cm³ and cooling product to 2.5 °C, all other values equal to Table 1”

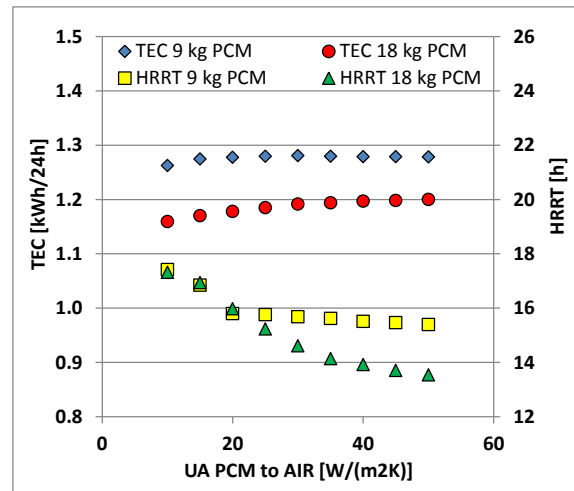

Figure 9: TEC and HRRT for increasing heat transfer between the PCM and the internal air. “PCM of 0 °C, compressor of 4.5 cm³ and cooling product to 2.5 °C, all other values equal to Table 1”

From Figure 9 it is seen that also the heat exchange between the internal air and the PCM has a minimum in HRRT for a given PCM mass, due to the same reason as previously discussed. The results also show a marginal influence of the heat transfer between the PCM and the internal air on the TEC. This results from the fact that the temperature lift of the cooling system, excluding the ambient, is only affected by the heat exchange between the PCM and the evaporator and the heat exchange between the internal air and the fin and tube heat exchanger.

The modelling showed that active PCM can be effectively applied to reduce the HRRT, thereby opening the possibility to apply a smaller compressor operating at reduced temperature lift and thereby at increased appliance efficiency. The modelling also showed that the phase change temperature of the PCM should be below the desired product temperature. This combined with the desire to operate at maximum evaporation temperature, limits the range of PCM materials available. Within the project, water / ice, due to the phase change temperature at 0 °C, small subcooling (measured at -2 °C) and the relatively high thermal conductivity of ice ($2.1 \text{ Wm}^{-1}\text{K}^{-1}$) showed to be the most promising PCM.

7. TEST RESULTS

A demonstrator appliance fitted with 8.7 kg PCM (water), based on the discussed design has been built (Figure 1) and is experimentally evaluated. Energy consumption and half reload recovery tests, according to the test protocol (HE, 2013), were performed at ambient temperatures of 25 and 32 °C. The main results of these tests are presented in Table 2. The appliance energy consumption was measured using a Yokogawa WT230 power meter and the can temperatures were measured using T-type thermocouples and a Fluke Helios I 2289A data acquisition module.

Table 2: Input parameters of the simulation model

	Ambient 25 °C / 60% Rh	Ambient 32 °C / 65 %Rh
Half reload recovery time	10.46 h	15.8 h
Average power consumption during HRR	0.0745 kW	0.0811 kW
Average power consumption during 24 h steady state (including business and non-business operation)	0.0315 kW	0.0446 kW
Average product temperature during steady state	1.2 °C	1.3 °C
Product temperature spread during steady state	2.1 K	3.0 K
Total appliance energy consumption	0.89 kWh/24h	1.24 kWh/24h

The tests showed that that the appliance meets the 16 h half reload recovery specification at an ambient temperature of 32 °C and has a total appliance energy consumption of TEC = 0.89 kWh/24h at an ambient of 25 °C.

Comparison of the test results with the calculations, section 6, shows acceptable agreement. A slightly lower TEC (1.24 kWh/24h) is measured than calculated for an equal size compressor (1.28 kWh/24h) and the measured HRRT (15.8 h) is slightly longer than calculated (15 h). This difference is assumed to result from differences in the overall heat transfer values, the power consumption of the controller (3 W, which is not included in the model) and the use of a compressor with 10% higher efficiency in the demonstrator.

8. DISCUSSIONS

The demonstrator appliance is fitted with prototype controllers. By optimization of the electronics, the power consumption of the controller can be reduced from 3 to 1 W. Further energy consumption reduction is expected from improving the sealing of the door, minimizing the cycling losses (charge reduction) and further optimization of the heat exchangers. It is assumed that implementation of these additional optimization steps will result in a further reduction in appliance TEC from 0.85 to approximately 0.80 kWh / 24h.

The demonstrator appliance as built is equipped with high end insulation materials, only. However, the principle of improving peak cooling capacity through using active PCM and thereby enabling the use of a smaller cooling system operating at reduced temperature lift can also be applied to less insulated appliances.

The resulting difference in TEC, in between 4 and approximately 15% depending on the size of the PCM evaporator and the HRR temperature specification, indicates that the efficiency of the compressor becomes a critical parameter. Due to the typical relation between compressor efficiency and swept volume (i.e. increasing COP with increasing swept volume), a slightly larger capacity compressor than required resulted for the practical design.

Another advantage, which is not further accessed within the study, of using a smaller compressor in combination with PCM is the reduction in compressor cycling. Coulter and Bullard (1995) showed that due to the compressor cycling a domestic refrigerator operates 5 to 25% less efficient than a corresponding quasi-steady refrigerator. They also showed that a major contributor for this efficiency loss is in the refrigerant migration from the condenser to the evaporator during the off cycle of the compressor. For the demonstrator operating at an ambient of 25 °C, a compressor cycle time of 4.8 h was measured. This is an increase in cycle time of 118% compared to the practical benchmark, for which a cycle time of 2.2 h was measured. Thereby reducing the losses associated by the migration of refrigerant with a factor 2.

9. CONCLUSIONS

The project was concluded with a demonstrator appliance, fitted with a very small (5.19 cm³) R-600a compressor, having a total energy consumption of 0.89 kWh/24h while fulfilling a HRR within 16 h at an ambient of 32 °C. This is an 85% reduction in TEC compared to the state of the art bottle coolers (2010 figures) and a 77.5% reduction compared to the standard glass door beverage cooler selected as practical benchmark. The largest part of this energy consumption reduction (> 90%) resulted from the heat load reducing measures applied (e.g. walls, glass door and

fan) and using relatively large heat exchangers in combination with a very efficient compressor. The final step was achieved by the use of active PCM.

Analysis performed showed a reduction in total appliance energy consumption in between 4 to 10% for implementation of active PCM on a glass door bottle cooler fitted with state of the art energy reducing options. The analyses also showed that the impact of active PCM is strongly related to the desired product temperature. The closer the PCM phase change temperature range to the appliance steady state temperature and the smaller the difference between the HRR temperature specification and the steady state temperatures, the smaller the impact of active PCM on appliance TEC.

Due to the components required (i.e. additional PCM evaporator + ice state control), applying active PCM is only seen as an additional energy reducing measure after including the more standard heat load reducing and system efficiency increasing options. For most commercial coolers large steps still can be made by implementation of these standard options. For domestic refrigerators most of the standard options are already implemented and applying active PCM is an option to further reduce the appliance energy consumption in the order of 2% to 10%, especially when appliance cooling down performance becomes a design aspect.

NOMENCLATURE

A	Area	(m ²)	TEC	Total Energy Consumption	(kWh/24h)
COP	Coefficient of Performance	(-)	U	Heat transfer coefficient	(Wm ⁻² K ⁻¹)
HRRT	Half Reload Recovery Time	(h)	UA	Overall heat transfer value	(WK ⁻¹)
k	Thermal conductivity	(Wm ⁻¹ K ⁻¹)	x	Vapor fraction	(kg/kg)

REFERENCES

- Azzouz, K. Leducq, D., Gobin, D., 2009, Enhancing the performance of household refrigerators with latent heat storage: An experimental investigation, *Int. J. of refrigeration*, Volume 32, Issue 7, P. 1634-1644.
- Cheng, W.L., Mei, B.J., Liu, Y.N., Huang, Y.H., Yuan, X.D., 2011, A novel household refrigerator with shape-stabilized PCM (Phase Change Material) heat storage condensers: An experimental investigation, *Int. J. of Energy*, Volume 68, Issue 10, P. 5797-5804.
- Coulter, W. H., Bullard, C. W., 1995, *An Experimental Analysis of Cycling Losses in Domestic Refrigerator-Freezers*, University of Illinois, Illinois, 97 p.
- Gin, B., Farid M.M., Bansal, P.K., 2010, Effect of door opening and defrost cycle on a freezer with phase change panels, *Int. J. Energy Conversion and Management*, Volume 51, Issue 12, P. 2698-2706.
- HE, 2013, *Fridges specification & test protocol Version. 3.1*, Heineken International, Amsterdam, 30 p.
- Joint Research Centre, 2014, Chapter 6.5 Beverage coolers, *Ecodesign for Commercial Refrigeration*, Publication office of the European Union, Luxembourg, p. 89 to 95.
- Khan, I.H., Afroz, H.M.M., 2013, Effect of Phase Change Material on Performance of a Household Refrigerator, *Asian J. Applied Sciences*, Volume 6, Issue 2, P. 56-67.
- Lemmon, E.W., Huber, M.L., McLinden, M.O. NIST Standard Reference Database 23: Reference Fluid Thermodynamic and Transport Properties-REFPROP, Version 9.1, National Institute of Standards and Technology, Standard Reference Data Program, Gaithersburg, 2013

ACKNOWLEDGEMENT

This work has been conducted by the iCool Consortium sponsored by the E.U., under the FP7 framework, consisting of the following companies: FRIGOCON SA (Portugal), New Wave Innovation Ltd (U.K.), Saturn Engineering Ltd (Bulgaria), AFM Europe (Belgium), ZAE (Germany), Heineken Supply chain BV (the Netherlands) and Re/genT BV (the Netherlands). All assistance is gratefully acknowledged.