

2006

# Analysis of the Operational Characteristics of Multi System Through Steady State and Dynamic Simulation

Gilbong Lee  
*LG Electronics*

IlHwan Lee  
*Seoul National University*

Keunjoong Yoo  
*Seoul National University*

Minsoo Kim  
*Seoul National University*

Samchul Ha  
*LG Electronics*

Follow this and additional works at: <http://docs.lib.purdue.edu/iracc>

---

Lee, Gilbong; Lee, IlHwan; Yoo, Keunjoong; Kim, Minsoo; and Ha, Samchul, "Analysis of the Operational Characteristics of Multi System Through Steady State and Dynamic Simulation" (2006). *International Refrigeration and Air Conditioning Conference*. Paper 812. <http://docs.lib.purdue.edu/iracc/812>

This document has been made available through Purdue e-Pubs, a service of the Purdue University Libraries. Please contact [epubs@purdue.edu](mailto:epubs@purdue.edu) for additional information.

Complete proceedings may be acquired in print and on CD-ROM directly from the Ray W. Herrick Laboratories at <https://engineering.purdue.edu/Herrick/Events/orderlit.html>

## Analysis of the operational characteristics of multi system through steady state and dynamic simulation

Gilbong LEE<sup>1</sup>, Il Hwan LEE<sup>2</sup>, Keun Joong YOO<sup>2</sup>, Min Soo KIM<sup>2†</sup>, and Samchul HA<sup>1</sup>

<sup>1</sup>Digital Appliance Research Laboratory, LG Electronics, Seoul 153-802, Korea

<sup>2</sup>School of Mechanical and Aerospace Engineering, Seoul National University, Seoul 151-742, Korea

<sup>†</sup> Corresponding author. Tel.: +82-2-880-8362; Fax.: +82-2-883-0179  
E-mail address: minskim@snu.ac.kr

### ABSTRACT

Steady state simulation and dynamic simulation were performed to analyze the effect of operation conditions of each indoor unit of a multi-type air conditioning system. Lumped parameter model and fully distributed model were applied to simulate the steady state and transient responses of the system considering the dynamic natures of each component. Since the main purpose is to analyze the effect of one indoor unit on the other unit, numerical simulations were carried out for the variations of secondary fluid inlet temperature, mass flow rate and expansion valve opening. The results showed that the inlet temperature and mass flow rate of the secondary fluid of one indoor unit had minor effect on the operation of the other unit. However, the opening of the expansion valve had significant effect on the performance of the other unit.

### 1. INTRODUCTION

As higher standard of living is pursued, there are tendencies that more than one air conditioning units are installed in a single or apartment house. The cost and space for the installation of air conditioning unit have become a major factor. Multi-type heat pump system can satisfy the same needs for the installation of several individual units with less space since it consists of one outdoor unit and multiple indoor units. It can handle cooling requirement in summer and also heating requirement in winter. In the respect of cost and space, multi-type heat pump system has much more merits than conventional air conditioning system. However, the system's complexity and lack of control strategy on multi-type heat pump system hinder its appearance as a major air conditioning system in the market. As more focus is given on the efficiency of a system during its operation, it has become more important to effectively analyze multi system performance.

There are two methods to investigate the performance of refrigeration system; experiment and numerical simulation. Many researchers investigated the refrigeration system through experimental methods because it is difficult to simulate the refrigeration system due to its complexity in thermodynamic processes. For example, phase changes which occur almost everywhere in the refrigeration system prevent researchers to accurately describe the operational characteristics and predict the performance. However, when we design a new system and estimate its performance, it is obviously efficient to perform a numerical simulation before experiments. Early works on the numerical simulation were directed toward the steady-state performance analysis. This steady-state evaluation can be used as a basic criterion to construct a new system or modify existing system.

When we control the capacity of the system, the system stays in the transient state for the most part of its operation. It takes considerable amount of time for the system to reach another steady-state, and the system may reach unwanted operation state where the system shows poor performance. So we need to analyze the transient characteristics as well as the steady-state performance.

The modeling of the components of refrigeration system is classified into three categories; lumped parameter model, time-constant model, and fully distributed model. The lumped parameter model assumes a component as one element and the input and output values are calculated (Chi and Didion, 1982). For the compressor and the expansion device, lumped parameter model have been generally applied since the transient behavior of the compressor and the expansion device usually show faster responses compared with other components like heat

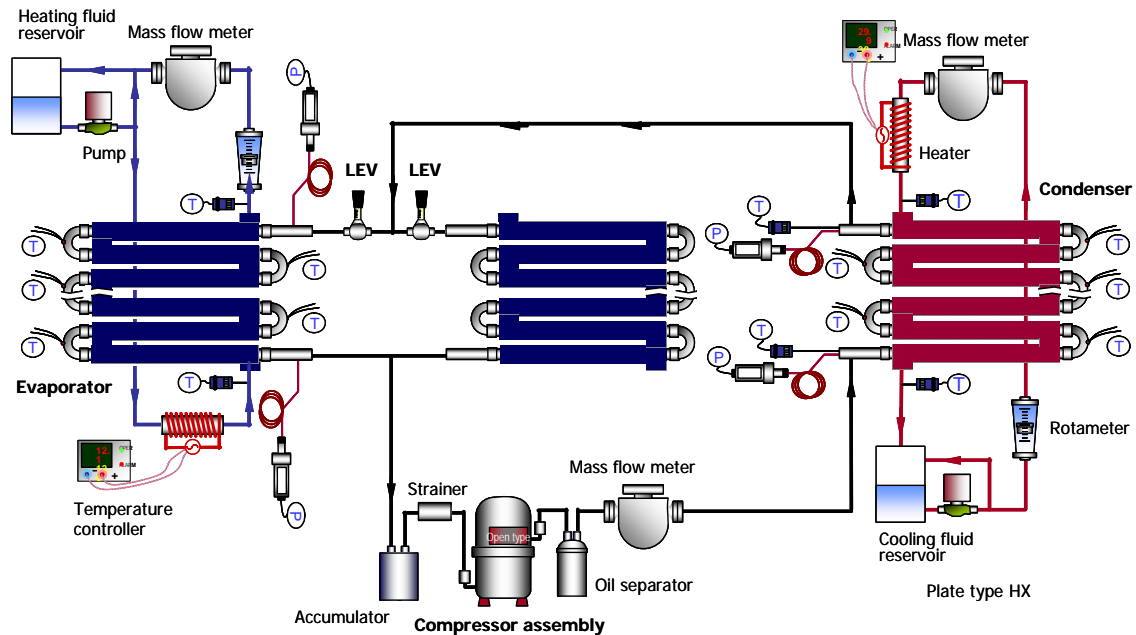

Figure 1: Schematic diagram of the multi-type air conditioning system for the simulation

exchangers. The lumped parameter method was applied to simulate the characteristics of the heat exchangers in the early stage of numerical simulation because it is easy to use and fast to calculate. This method is also applied to derive a system model that is used to design optimal controller based on modern system theory (He *et al.*, 1998). Tree and Weiss (1985) adopted two-time-constant method to represent the different characteristics during transient response. The first time constant represents the startup transition time and is determined based on the time required to remove excessive refrigerant from the evaporator. The second time constant is determined based on the time required for a steady-state operation. They showed that two-time-constant approach could be used to model the indoor coil of a heat pump both in heating and cooling mode.

MacArthur and Grald (1989) suggested a fully distributed model for heat exchanger analysis and predicted the dynamic heat pump performance. Fully distributed method can well represent the nonlinear characteristics of a system but it requires a lot of calculation time and computing source. However fully distributed method enhanced the reliability of numerical simulation in transient response, so nowadays many researchers use this method (Kim *et al.*, 2001).

In this study, fully distributed method was used for the heat exchangers. Lumped parameter method was applied for the compressor and expansion devices. The main focus of the numerical analysis is to investigate the effect of the operation conditions of one indoor unit on the other unit.

## 2. COMPONENT MODELING

Figure 1 shows the schematic diagram of multi type air conditioning system. The heat exchangers are counter-flow type and composed of two concentric copper tubes. The indoor units and outdoor unit have the same geometry with inner diameter of 9.53 mm, outer diameter of 15.9 mm. The total length of outdoor unit is 13 m and the total length of each indoor unit is 10 m. The refrigerant is R410A and the secondary fluid is water. The properties for the refrigerant, R410A, are obtained by using REFPROP 7.0 (Lemmon *et al.*, 2002). The properties of water are assumed to be constant.

### 2.1 Compressor

The steady-state performance of the compressor can be described by an isentropic efficiency or polytropic coefficient. In this study, isentropic efficiency is used to describe the compressor. With isentropic efficiency, the enthalpy of the refrigerant exiting the compressor is determined by Equation (1).

$$h_d = h_s + \frac{h_{d,isen} - h_s}{\eta_{isen}} \quad (1)$$

$h_s$  is the enthalpy at the compressor suction and  $h_{d,isen}$  is the discharge enthalpy if the compression process is isentropic. The mass flow rate through compressor is obtained by inlet conditions and volumetric efficiency. The volumetric efficiency used in this study is defined by Equation (2)

$$\eta_v = 1 - C \left[ c_1 \left( \frac{P_d}{P_s} \right)^{c_2} \text{rps}^{c_3} - 1 \right] \quad (2)$$

where the coefficients are determined empirically;  $C=-0.4715$ ,  $c_1=0.322$ ,  $c_2=0.7187$ ,  $c_3=-0.0625$ . The mass flow rate of the refrigerant is determined by Equation (3) and Equation (4)

$$\dot{V}_{comp} = \dot{V} \cdot \eta_v \quad (3)$$

$$\dot{m}_r = \frac{\dot{V}_{comp}}{v_s} \quad (4)$$

### 2.2 Heat exchangers

One dimensional flow assumption is applied both for the refrigerant and secondary fluid. If we neglect the pressure drops, the governing equations in the heat exchangers are written as follows (Rasmussen and Alleyne, 2004)

$$\frac{\partial(\rho A)}{\partial t}_r + \frac{\partial \dot{m}_r}{\partial z} = 0 \quad (5)$$

$$\frac{\partial(\rho A h - AP)}{\partial t}_r + \frac{\partial(\rho \dot{m} h)}{\partial z}_r = U\tilde{P}(T_w - T_r) \quad (6)$$

$$(\rho A C_p)_w \frac{\partial T_w}{\partial t} + (\dot{m} c_p)_w \frac{\partial T_w}{\partial z} = U\tilde{P}(T_r - T_w) \quad (7)$$

Figure 2 shows the cross-section of the heat exchanger and discretized cell. The thermodynamic properties in the control volume are assumed to be constant and calculated by assuming the refrigerant is in an equilibrium state.

### 2.3 Expansion devices

The expansion device is modeled as an orifice (Equation (8)). The general orifice equation is used to calculate the mass flow rate through the device. The range of inputs of expansion valve is 0 to 500. Input '0' means maximum

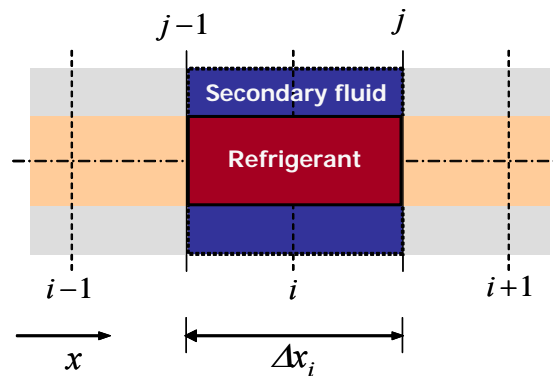

Figure 2: Numbering convention of the control volume at heat exchanger

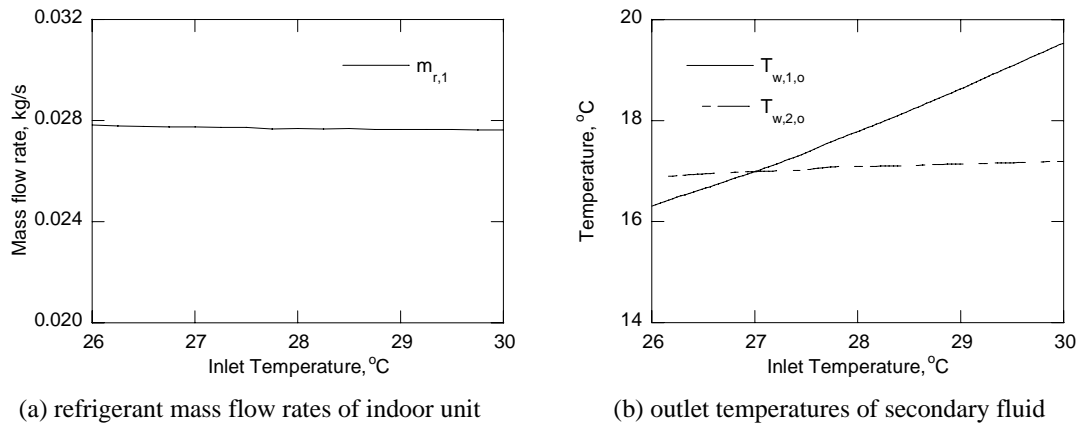

Figure 3: The results of the steady state simulation when  $T_{w,1,i}$  is changed from 26°C to 30°C.

opening and ‘500’ means minimum opening and the expansion process is assumed to be isenthalpic.

$$\dot{m}_r = C_d A \sqrt{2\rho_3(P_2 - P_1)} \tag{8}$$

### 3 STEADY STATE PERFORMANCE EVALUATIONS

The main focus of the numerical analysis is to investigate the effect of the operation conditions of one indoor unit on the other indoor unit. So the operation condition of outdoor unit and the effect of compressor speed were not considered in this study. Simulations were carried out for the 3 cases; the change in the flow rate of the secondary fluid, the change in the inlet temperature of the secondary fluid, and the change in the opening of the expansion valve. Only the working conditions of indoor unit 1 were modified while those of indoor unit 2 remained constant. The reference value for the inlet temperature is 27°C, for the mass flow rate 0.010 kg/s, and for the input of LEV 320.

Figure 3 shows the effect of the inlet temperature. As the inlet temperature is increased, the outlet temperature of indoor unit 2 is slightly increased from 16.9°C to 17.2°C. Since the temperature change has minor effect on the system pressure, the mass flow rate of the refrigerant does not show significant change. The flow rate is slightly decreased and this is related to the minor increase of temperature in the indoor unit 2. Figure 4 is the variations of the outlet temperatures when the mass flow rate increases. Similar to the temperature increase cases, the outlet temperature of the indoor unit 2 is slightly increased but the effect is minor. Based on Figure 3 and Figure 4, it can be said that the inlet conditions of secondary fluid have a minor effect on the other indoor unit. That is, the indoor units operate almost independently of the inlet conditions of the secondary fluid of the other unit.

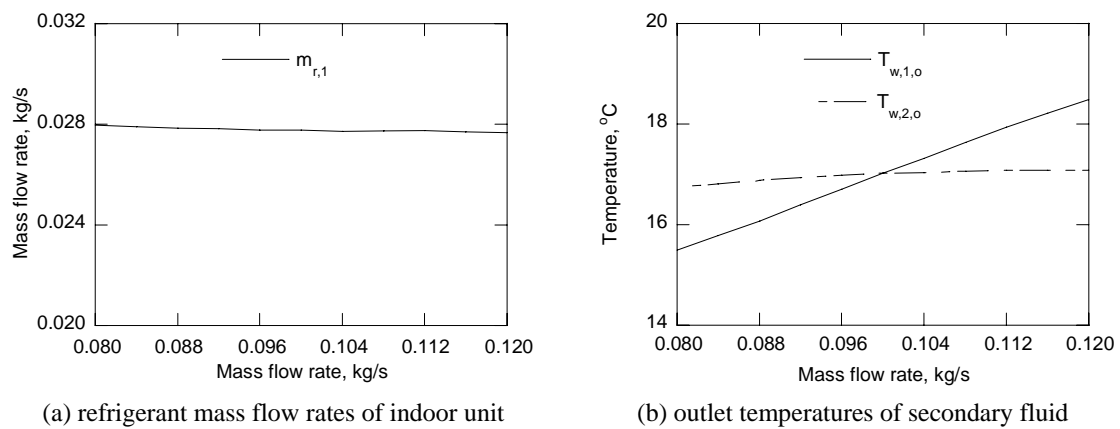

Figure 4: The results of the steady state simulation when  $\dot{m}_{w,1}$  is changed from 0.080 kg/s to 0.120 kg/s.

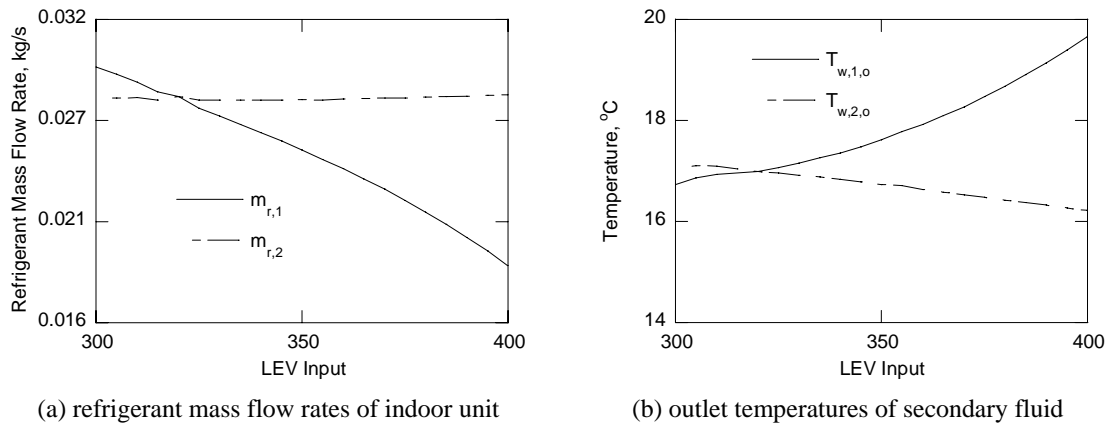

Figure 5: The results of the steady state simulation when the input to the LEV of indoor unit 1 is changed from 300 to 400.

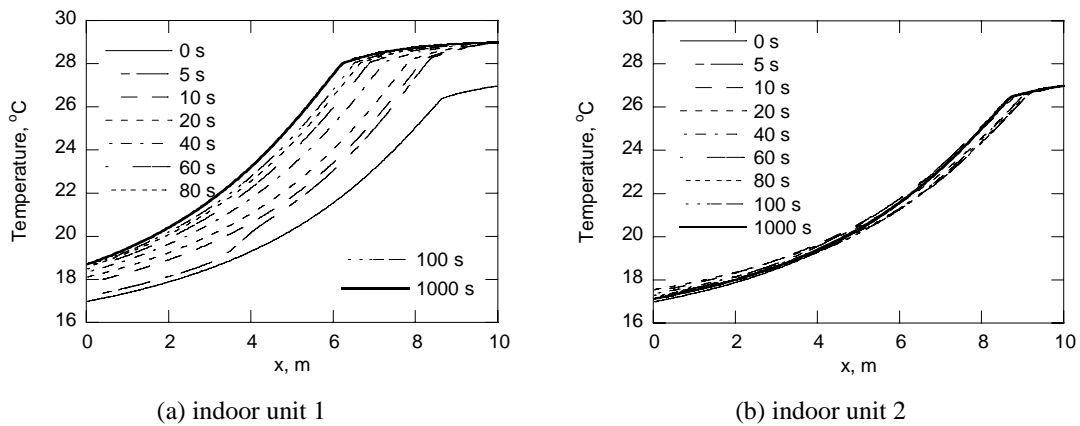

Figure 6: The transient response of the secondary fluid temperature profiles of indoor units when  $T_{w,1,i}$  is changed from 27°C to 29°C.

Figure 5 shows the effect of the opening of the expansion valve. Compared to the previous cases, there are remarkable changes in the outlet temperature. As the opening of the expansion valve decreases, the mass flow rate of the refrigerant of indoor unit 1 is decreased. Because the opening of the expansion valve of indoor unit 2 is fixed at constant value, the ratio of the opening of indoor unit 2 to the opening of indoor unit 1 is increased. Thus there is no significant change in the mass flow rate of the refrigerant through indoor unit 2. Low saturation temperature resulted from the decrease of expansion valve makes the outlet temperature of the indoor unit 2 decrease. Since the mass flow rate has more effect on the outlet temperature than the saturation temperature, the outlet temperature of the indoor unit 1 is increased.

#### 4 TRANSIENT CHARACTERISTICS OF MULTI TYPE AIR CONDITIONING SYSTEM

Transient simulations were carried out for the similar cases of the steady state. Each simulation was carried out for 1000 seconds and the final values were regarded as the steady state values.

Figure 6 shows the variations of the temperature profiles of the secondary fluid in indoor units when the inlet temperature of the secondary fluid of indoor unit 1 was suddenly increased by two degrees, from 27°C to 29°C. After 5 seconds, the sudden temperature increase is not propagated completely as there is a steep region in the temperature profile. Around 20 seconds after the change, the outlet temperature of indoor unit 2 takes its maximum value. Then the temperature decreases steadily to its final state. As the rise in the inlet temperature, the superheated region is increased due to the change in  $\Delta T$ . However, the temperature distributions in the indoor unit 2 are slightly

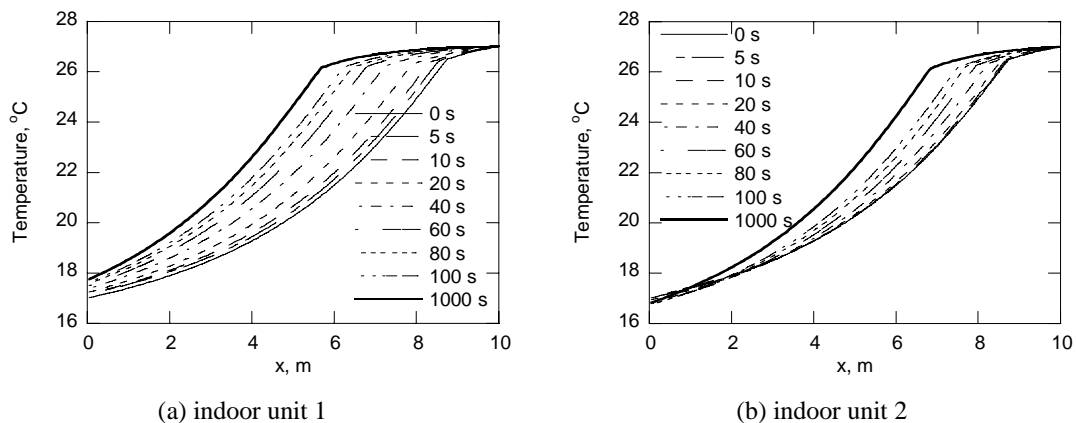

Figure 7: The transient response of the secondary fluid temperature profiles of indoor units when the input to the LEV of indoor unit 1 is changed from 320 to 350.

changed. The superheated region is increased and the outlet temperature is increased. But the magnitude of the variation is much smaller. The increase in the inlet temperature gives minor effect on the temperature distribution in the condenser and a very little change is occurred in the temperature profiles.

Figure 7 shows when the input to the LEV is changed from 320 to 350. Since the opening of the expansion valve is decreased, the mass flow through the indoor unit 1 is decreased. This causes the increase of the superheated region and the temperature gradient of the secondary fluid at the two-phase region becomes steeper. The temperature profile changes more obviously than previous cases, and more time is needed to reach the steady state. The superheated zone of the indoor unit 2 is also changed due to the LEV change. But the outlet temperature change can be said to be negligible compared to the temperature change at other positions. Figure 8 shows the outlet temperatures of indoor units. The outlet temperature of indoor unit 1 steadily increases to its final value as the opening of indoor unit 1 is reduced. As the reduction in the expansion valve opening causes the decrease in evaporation pressure, the outlet temperature of indoor unit 2 decreases and has its minimum value around 80 s.

## 5. CONCLUSION

Both steady state simulation and transient simulation were performed for the multi type air conditioning system. The interrelationships between indoor units were investigated in the simulation. From the steady state evaluation, it was shown that the inlet states of the secondary fluid give trivial effect on the other indoor unit. But the change in the opening of LEV causes significant changes in the system. As the input of the LEV of indoor unit 1 was increased, the outlet temperature of indoor unit 1 was increased while that of indoor unit 2 decreased. There was more temperature increase than temperature decrease.

The transient analysis was performed for two cases of operation conditions changes of indoor unit 1; inlet temperature increase and the decrease of opening. The working conditions of indoor 2 were fixed during the simulations. Similar trends to the steady simulation were found in the transient simulation. The inlet temperature gave a minor effect on the transient behavior of the indoor unit 2. However, the LEV change affected the transient movements of indoor unit 2 significantly. Even though the outlet temperature of indoor unit 2 did not change much, the overall shape of temperature profile took a different shape. Considerable amount of time was required to reach the final states.

The simulation methods of this study can be applied to make a new system, evaluate an existing system or design a controller for the refrigeration system. Especially the transient simulation can give important information required to develop the controller since the design of a controller is strongly based on the transient characteristics of the system.

## ACKNOWLEDGEMENT

This study is supported by Korea Energy Management Corporation and Micro Thermal System Research Center of Seoul National University. The support from the BK21 program is greatly appreciated.

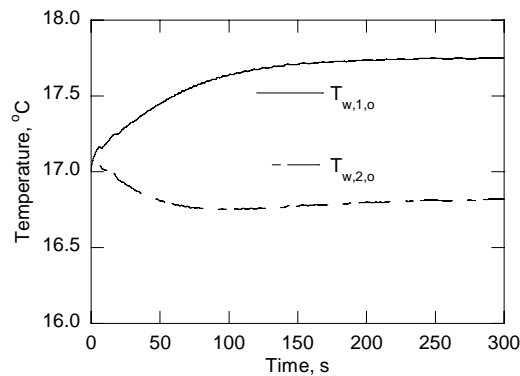

Figure 8: The variations of outlet temperatures under the change of the input to the LEV of indoor unit 1

### NOMENCLATURE

$A$	area	( $m^2$ )		<b>Subscripts</b>
$C_d$	flow coefficient	(-)	1	compressor inlet, indoor unit 1
$C_p$	specific heat capacity	( $kJ/kg \cdot K$ )	2	compressor outlet, indoor unit 2
$h$	enthalpy	( $kJ/kg$ )	3	condenser outlet
$\dot{m}$	mass flow rate	( $kg/s$ )	$i$	inlet
$P$	pressure	( $kPa$ )	$isen$	isentropic process
$\tilde{P}$	perimeter	( $m$ )	$o$	outlet
$U$	overall heat transfer coefficient	( $kJ/m^2 \cdot K \cdot s$ )	$r$	refrigerant
$V$	volume	( $m^3$ )	$v$	volume
$v$	specific volume	( $m^3/kg$ )	$w$	secondary fluid
$\eta$	efficiency	(-)		
$\rho$	density	( $kg/m^3$ )		

### REFERENCES

- Chi, J. and Didion, D., 1982, A simulation model of the transient performance of a heat pump, *Int. J. Refrig.*, Vol. 5, No. 3, pp. 176-184.
- Tree, D. R. and Weiss, B. W., 1985, Two time constant modeling approach for residential heat pumps, *Proceedings of the American Control Conference*, pp. 276-281.
- MacArthur, W. J. and Grald, E. W., 1989, Unsteady compressible two-phase flow model for predicting cyclic heat pump performance and a comparison with experimental data, *Int. J. Refrig.*, Vol. 12, No. 1, pp. 29-31.
- He, X., Liu, S., Asada, H. H., and Itoh, H., 1998, Multivariable control of vapor compression systems, *HVAC&R Research*, Vol. 4, No. 3, pp. 205-230.
- Kim, M., Kim, M. S., and Baek, N. C., 2001, Numerical simulation on dynamic characteristics of a water heater system driven by a heat pump, *Korean Journal of Air-Conditioning and Refrigeration Engineering*, Vol. 14, No. 1, pp. 10-21.
- Lemmon, E. W., McLinden, M. O., and Huber, M. L., 2002, NIST Reference fluid thermodynamics and transport properties - REFPROP, Version 7.0, *National Institute of Standards and Technology*, Gaithersburg, MD, U.S.A.
- Rasmussen, B. P. and Alleyne, A. G., 2004, Control-oriented modeling of transcritical vapor compression systems, *Trans. of the ASME*, Vol. 126, pp. 54-64.