

1988

# An Analysis of Losses In Scroll Compressor

Makoto Hayano  
*Toshiba Corporation*

Hirotaugu Sakata  
*Toshiba Corporation*

Shigemi Nagatomo  
*Toshiba Corporation*

Hiroaki Murasaki  
*Toshiba Corporation*

Follow this and additional works at: <https://docs.lib.purdue.edu/icec>

---

Hayano, Makoto; Sakata, Hirotaugu; Nagatomo, Shigemi; and Murasaki, Hiroaki, "An Analysis of Losses In Scroll Compressor" (1988). *International Compressor Engineering Conference*. Paper 620.  
<https://docs.lib.purdue.edu/icec/620>

This document has been made available through Purdue e-Pubs, a service of the Purdue University Libraries. Please contact [epubs@purdue.edu](mailto:epubs@purdue.edu) for additional information.

Complete proceedings may be acquired in print and on CD-ROM directly from the Ray W. Herrick Laboratories at <https://engineering.purdue.edu/Herrick/Events/orderlit.html>

# AN ANALYSIS OF LOSSES IN SCROLL COMPRESSOR

Makoto HAYANO, Hirotsugu SAKATA, Shigemi NAGATOMO and Hiroaki MURASAKI  
Consumer Products Engineering Laboratory, Toshiba Corporation  
8 Shinsugita, Isogo-ku, Yokohama 235, JAPAN

## ABSTRACT

A mathematical model for predicting frictional losses in scroll compressors has been developed. By using this model, each frictional loss in lubricated elements can be calculated. The calculated results show that most of the losses occur between the bearings and the shaft, and between the orbiting and the fixed scroll.

On the other hand, an indicator diagram is obtained by measuring the compression process. Compression losses are obtained by this diagram. Experimental results show that the leakage loss is greater than other compression losses.

The sum of the frictional losses is also obtained by the indicator diagram. The sum of the calculated frictional losses agrees well with the experimental result. It has been clarified that the mathematical model is useful for predicting the mechanical losses.

## INTRODUCTION

Scroll compressors have been studied and developed in recent years; research on a simulated compression process[1], an analysis of mechanical efficiency[2][3], an analysis of forces acting on various parts[4][5][6], and an optimization of dimensions[7] have been reported. But an analysis of the factors affecting the scroll compressor performance has apparently not been performed in detail.

To improve compressor performance, compression, mechanical and motor losses have to be reduced. Mechanical losses, or the frictional losses have to be obtained by calculation, because it is difficult to measure each frictional loss individually. In this study, a mathematical model for predicting the frictional losses has been developed. Analytical models for the orbiting scroll and the Oldham coupling which are similar to the former reports[2][6] were made. The fundamental equation for the journal bearing was applied to the crank bearing. The forces acting on each lubricated element and the losses occurring in each lubricated element were obtained.

On the other hand, an indicator diagram is obtained by measuring the compression process. Over-compression, wiredrawing, and other compression losses are obtained by this diagram. The sum of the frictional losses is also obtained by this diagram to confirm the validity of the mathematical model for predicting the frictional losses.

## NOMENCLATURE

$a$	radius of oil pump in shaft
$A_w$	balancing weight sectional area
$B$	key width
$C$	radial clearance between shaft and bearing
$C_d$	drag coefficient
$D$	diameter
$F_c$	radial force acting on orbiting scroll
$F_{hp}$	upward force by pressure chamber
$F_i$	centrifugal force of orbiting scroll
$F_{i1} \sim F_{i3}$	centrifugal force of balancing weight
$F_{i4}$	centrifugal force of crank shaft
$F_{th}$	thrust force acting on orbiting scroll

g	acceleration of gravity
H	head of oil pump
$h_o$	key height
$h_w$	height of rotor or height of shaft in oil reservoir
$K_f$	coefficient of friction factor
L	bearing length
$L_b$	frictional loss in bearing
$L_d$	loss due to viscous resistance of refrigerant gas or oil
$L_o$	frictional loss between Oldham coupling and frame
$L_k$	frictional loss between key and key way
$L_{op}$	oil pump loss
$L_R$	frictional loss between shaft and frame
$L_s$	frictional loss between orbiting and fixed scroll
$l_o$	oil pump length
$M_b$	viscous moment of oil film in bearing
N	number of rotations
$P_b$	bearing surface load
Q	flow rate of oil
R	eccentric radius of centrifugal oil pump
$R_b$	bearing load
$R_{kl} \sim R_{k4}$	Oldham coupling load
$R_o$	frame resistance force acting on Oldham coupling
$R_s$	fixed scroll resistance force acting on orbiting scroll
r	radius of bearing
$r_{om}$	radius of Oldham coupling
$r_R$	radius of shaft thrust bearing
$r_s$	orbiting radius
$r_w$	radius of rotor or radius of shaft in oil reservoir
$Sm$	Sommerfeld number
$t_o$	Oldham coupling thickness
$U_m$	Peripheral velocity of shaft
W	weight of orbiting scroll
$W_o$	weight of Oldham coupling
$W_s$	weight of shaft and rotor
$x_o, y_o$	distance shown in Fig. 3
$x_s, y_s$	distance shown in Fig. 2
$y_{k1}, y_{k2}$	distance shown in Fig. 2; $y_{k1} = r_{om} - r_s \sin\theta$ , $y_{k2} = r_{om} + r_s \sin\theta$
$Z_c, Z_g, Z_k, Z_s$	distance shown in Fig. 2
$\mu_1 \sim \mu_4$	coefficient of friction between key and key way
$\mu_b$	coefficient of friction between shaft and bearing
$\mu_o$	coefficient of friction between Oldham coupling and frame
$\mu_R$	coefficient of friction between shaft and frame
$\mu_s$	coefficient of friction between orbiting and fixed scroll
$\zeta$	coefficient of loss in oil pump
$\nu$	coefficient of kinematic viscosity
$\gamma$	specific weight

$\eta$       viscosity  
 $\theta$       crank angle  
 $\omega$       angular velocity

subscript

$x$  : direction of x-axis  
 $y$  : direction of y-axis  
 $c$  : crank bearing  
 $m_1$  : upper main bearing  
 $m_2$  : lower main bearing  
 $s$  : sub-bearing

## MATHEMATICAL MODEL FOR PREDICTING FRICTIONAL LOSSES

### Test Compressor

The scroll compressor considered in this paper is shown in Fig. 1. The annular block is placed between the end plate of the orbiting scroll and the frame, and contains the pressure chamber. The orbiting scroll is pushed in the axial direction to the fixed scroll by an upward force which is produced by drawing the discharge gas into the pressure chamber[5]. Ten locations where frictional losses occur are assumed as shown in Fig. 1.

To make the model simple, the following assumptions are made:

- (1) Fluid lubrication is assigned to the bearings, and boundary lubrication is assigned to the other lubricated elements.
- (2) The coefficient of friction for the boundary lubrication is always constant.
- (3) The fundamental equation for the journal bearing under constant load is applied to the bearings; however, the load fluctuation is considered as quasi-steady state.
- (4) The angular velocity of the shaft is constant.

### Orbiting Scroll Model

The analytical model for the orbiting scroll is shown in Fig. 2. The equations of equilibrium in forces and moments are obtained as follows:

<force>

$$F_{cx} + F_i \cos\theta + \mu_s R_s \sin\theta + R_{k1} - R_{k2} - R_{bcx} = 0 \quad (\text{direction of x-axis}) \quad (1)$$

$$F_{cy} - F_i \sin\theta + \mu_s R_s \cos\theta + \mu_1 R_{k1} + \mu_2 R_{k2} - R_{bcy} = 0 \quad (\text{direction of y-axis}) \quad (2)$$

$$F_{hp} - W - F_{th} - R_s = 0 \quad (\text{direction of Z-axis}) \quad (3)$$

<moment>

$$\begin{aligned}
 -F_{cy} Z_c + F_i Z_g \sin\theta - \mu_s R_s Z_s \cos\theta - \mu_1 Z_k R_{k1} - \mu_2 Z_k R_{k2} \\
 + R_s y_s + F_{hp} r_s \sin\theta - F_{th} \frac{r}{2} \sin\theta = 0 \quad (\text{around x-axis}) \quad (4)
 \end{aligned}$$

$$\begin{aligned}
 -F_{cx} Z_c - F_i Z_g \cos\theta - \mu_s R_s Z_s \sin\theta + (R_{k2} - R_{k1}) Z_k \\
 - R_s x_s - F_{hp} r_s \cos\theta + F_{th} \frac{r}{2} \cos\theta = 0 \quad (\text{around y-axis}) \quad (5)
 \end{aligned}$$

$$\begin{aligned}
 -R_{k1} y_{k1} - R_{k2} y_{k2} - \mu_1 \frac{B}{2} R_{k1} + \mu_2 \frac{B}{2} R_{k2} + F_{cy} \frac{r}{2} \cos\theta \\
 + F_{cx} \frac{r}{2} \sin\theta - \mu_s R_s x_s \cos\theta - \mu_s R_s y_s \sin\theta + M_{bc} = 0 \quad (\text{around Z-axis}) \quad (6)
 \end{aligned}$$

### Oldham Coupling Model

The analytical model for the Oldham coupling is shown in Fig. 3. The equations of equilibrium in forces and moments are obtained as follows:

<force>

$$\mu_3 R_{k3} + \mu_4 R_{k4} + \mu_0 R_0 - R_{k1} + R_{k2} + \frac{W}{g} \frac{d^2}{dt^2} (r_s \cos \theta) = 0 \quad (\text{direction of x-axis}) \quad (7)$$

$$R_{k3} - R_{k4} - \mu_1 R_{k1} - \mu_2 R_{k2} = 0 \quad (\text{direction of y-axis}) \quad (8)$$

$$R_0 - W_0 = 0 \quad (\text{direction of z-axis}) \quad (9)$$

<moment>

$$(\mu_1 R_{k1} + \mu_2 R_{k2})(t_0 + h_0) + R_0 y_0 = 0 \quad (\text{around x-axis}) \quad (10)$$

$$(-R_{k1} + R_{k2})(t_0 + h_0) + R_0 x_0 + \mu_0 R_0 \frac{h}{2} + \frac{W}{g} \frac{d^2}{dt^2} (r_s \cos \theta) \frac{t_0 + h_0}{2} = 0 \quad (\text{around y-axis}) \quad (11)$$

$$(R_{k1} + R_{k2} - R_{k3} - R_{k4}) r_{om} + (\mu_1 R_{k1} - \mu_2 R_{k2} - \mu_3 R_{k3} + \mu_4 R_{k4}) \frac{B}{2} + \mu_0 R_0 y_0 = 0 \quad (\text{around z-axis}) \quad (12)$$

### Viscous Moment of Oil Film in Crank Bearing

The frictional loss occurring between the bearing and the shaft can be obtained by solving Reynolds' equation numerically; however, in this study, to make calculation simple, the pre-calculated coefficient friction factors  $K_f$  are used [8].

The equation for fitting are made as follows:

$$K_f = (18.48 + \frac{0.0571}{(L/D)^3}) S_m \sqrt{1 + \frac{0.1(L/D)^2 - 0.4(L/D) + 0.47}{S_m}} \quad (13)$$

The pre-calculated and the fitting value is shown in Fig. 4.

In Eq. (13),  $K_f$  and  $S_m$  are defined as follows:

$$K_f = \mu_{bc} \cdot r_c / C_c \quad \dots \dots (14), \quad S_m = \left( \frac{r_c}{C_c} \right)^2 \left( \frac{\eta N}{P_{bc}} \right) \quad (15)$$

where,

$$P_{bc} = R_{bc} / (L_c \cdot D_c) \quad \dots \dots (16), \quad R_{bc}^2 = R_{bcx}^2 + R_{bcy}^2 \quad (17)$$

therefore, the viscous moment of the crank bearing is obtained by the following equations:

$$M_{bc} = \mu_{bc} R_{bc} r_c = \frac{C_c}{r_c} K_f R_{bc} r_c \quad (18)$$

### Solving of Simultaneous Equations

In Eqs. from (1) to (18),  $F_{cx}$ ,  $F_{cy}$ ,  $F_i$ ,  $F_{hp}$  and  $F_{th}$  had already been obtained [4][5]; there are 18 unknown quantities. The forces acting on each lubricated element and the viscous moment of oil film in the crank bearing can be obtained by solving these 18 simultaneous equations as follows:

1.  $R_s$  in Eq. (3) is substituted into Eqs. (1), (2), (4), (5) and (6).
2.  $R_0$  in Eq. (9) is substituted into Eqs. (7), (8), (10), (11) and (12).
3. By solving 10 simultaneous equations of Eqs. (1) ~ (12) except Eqs. (3) and (9), the other unknown quantities are obtained as a function of  $M_{bc}$ ;

$$R_{bcx} = A_1 M_{bc} + B_1, \quad R_{bcy} = A_2 M_{bc} + B_2 \dots \quad (19)$$

where  $A_1, A_2, B_1, B_2$  are constant.

4.  $R_{bcx}$  and  $R_{bcy}$  in Eq. (19) are substituted into Eq. (17), and by solving the simultaneous equations of Eqs. (13) ~ (18),  $M_{bc}$  can be obtained.
5. The other unknown quantities can be obtained by substituting  $M_{bc}$  into Eq. (19).

#### Shaft Model

The analytical model of the shaft is shown in Fig. 5. The forces acting on the main bearings and the sub-bearing are obtained by applying the equation of three moments in a statically indeterminate beam.

#### Frictional Losses

<bearing>

By solving Eqs. (13) ~ (18) for  $\mu_b$ , the bearing losses are given by

$$L_b = \mu_b R_b U_m \quad (20)$$

<Oldham coupling key and key way>

$$L_k = \mu_1 \cdot R_k \cdot r_s \omega |\cos \theta| \quad (21)$$

<Oldham coupling and frame>

$$L_o = \mu_o W_o r_s \omega |\sin \theta| \quad (22)$$

<Orbiting and fixed scroll>

$$L_s = \mu_s R_s r_s \omega \quad (23)$$

<Shaft and frame>

$$L_R = \mu_R W_S r_R \omega / 2 \quad (24)$$

<Viscous resistance of refrigerant gas or oil>

$$L_d = Cd \frac{1}{2} \frac{\gamma}{g} V^2 A_w \quad (25)$$

<Oil pump>

$$L_{op} = \gamma \cdot Q \cdot R \quad (26)$$

where Q is obtained by solving the following equation:

$$(1 + \tau_1 + \tau_2) Q^2 + 16\pi\nu(1_o + R)Q - \pi^2 a^4 (R^2 \omega^2 - 2gH) = 0 \quad (27)$$

#### Calculation Results

Calculated frictional losses are shown in Figs. 6, 7 and Table 1. The calculated result shows that most of the frictional losses occur between the shaft and the bearings, and between the orbiting and the fixed scroll.

### EXPERIMENTS

The compression process is measured, the indicator diagram is obtained by this compression process, and an analysis of losses are made.

#### Measurement of Compression Process

The compression process is obtained by stacking 5 signals which come from 5 pressure transducers.

The indicator diagram is obtained from this compression process and the calculated volume; the indicated work, over-compression loss, the wiredrawing loss, and other compression losses are obtained. The measured indicator diagram is shown in Fig. 8.

The sum of the frictional losses is also obtained from the measured motor loss and compression loss. The experimental results are shown in Table 2. The heat loss and leakage loss are greater than any other losses in the scroll compressor.

#### Comparison of Mathematical Results with Experimental

Calculated and experimental frictional losses are compared. The sum of calculated frictional losses ratio is 7.2 (%), and the sum of the experimental one is 7.7 (%). The calculated result agrees well with the experimental result. It has been clarified that this mathematical model is useful for predicting the frictional losses.

#### Comparison of Scroll with Rotary Compressor

The losses in the scroll compressor are compared with that in the rotary compressor from Ref.[9] which is the same performance as the scroll compressor.

The leakage loss and the heat loss in the scroll compressor are greater than that in the rotary compressor. Since the pressure difference between the adjoining compression chambers is greater on the inside than on the outside, the leakage toward the suction side thought to be very small; however, inner leakage gas may be re-compressed. So, the leakage loss may occur. Since direct suction is not employed in the scroll compressor, the heat loss may occur.

Since the frictional loss between the orbiting scroll and the fixed scroll is inherent in the scroll compressor, the frictional losses may be greater than that in the rotary compressor.

But the wiredrawing loss, over-compression loss and reexpansion loss in the scroll compressor are very smaller than those in the rotary compressor.

To improve the performance of the scroll compressor, it is necessary to reduce the leakage loss and the frictional loss between the orbiting and fixed scroll.

#### CONCLUSIONS

1. A mathematical model for predicting each frictional loss in lubricated elements in scroll compressors has been developed.
2. It has been clarified that the mathematical model is useful for predicting frictional losses.
3. It has been clarified that the leakage loss and the frictional loss between the orbiting and the fixed scroll are high in the scroll compressor. To improve the performance of scroll compressors, it is necessary to reduce these losses.

#### REFERENCES

- [1] Tojo, K. et al., Computer Modeling of Scroll Compressor with Self Adjusting Back-Pressure Mechanism, Purdue Compressor Engineering Conference (PCEC), 1986.
- [2] Ishii, N. et al., Behavior of a Scroll Compressor, PCEC, 1986.
- [3] Ishii, N. et al., Mechanical Efficiency of Various Large Capacity Scroll Compressors (in Japanese), Transactions of the Japan Society of Mechanical Engineers (JSME), Vol. 53 C, No.496, Dec. 1987.
- [4] Morishita, E. et al., Scroll Compressor Analytical Model, PCEC, 1984.
- [5] Hayano, M. et al., Performance Analysis of Scroll Compressor for Air Conditioners, PCEC, 1986.
- [6] Morishita, E. et al., Scroll Compressor Dynamics (in Japanese), Trans. of JSME, Vol. 51B, No.466, June 1985.
- [7] Bush, J. W. et al., Dimension Optimization of Scroll Compressors, PCEC, 1986.
- [8] JSME Mechanical Engineers' Handbook
- [9] Matsuzaka, T. et al., Rolling Type Rotary Compressor Performance Analysis, PCEC, 1982.

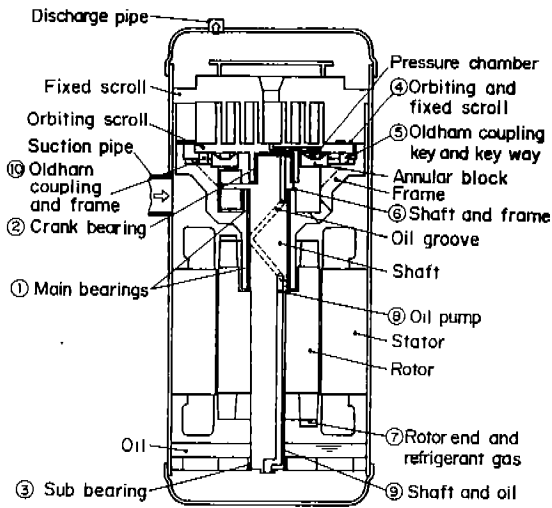

Fig.1 Scroll Compressor Construction

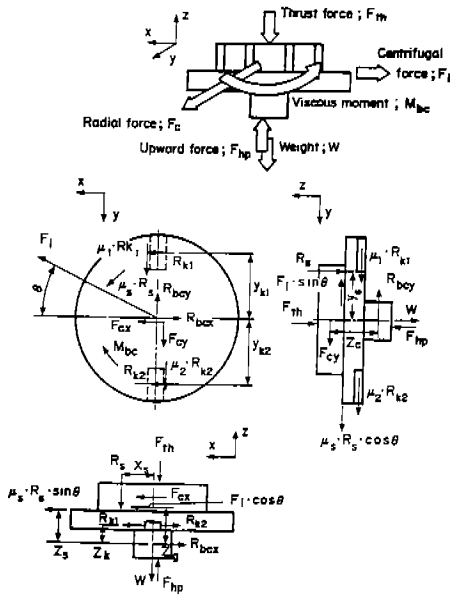

Fig.2 Analytical Model for Orbiting Scroll II

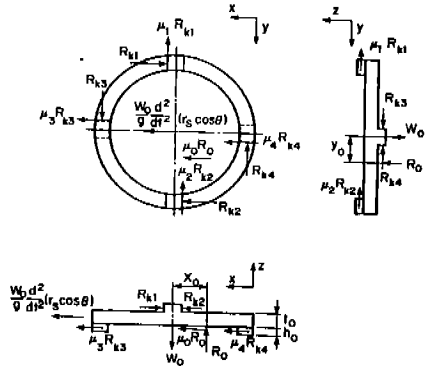

Fig.3 Analytical Model for Oldham Coupling



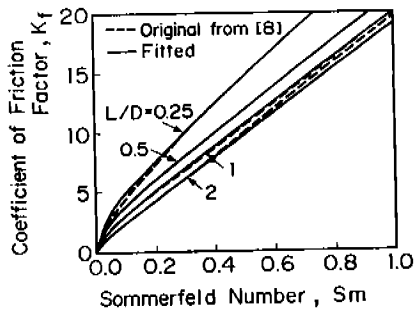

Fig. 4 Coefficient of Friction vs. Sommerfeld Number

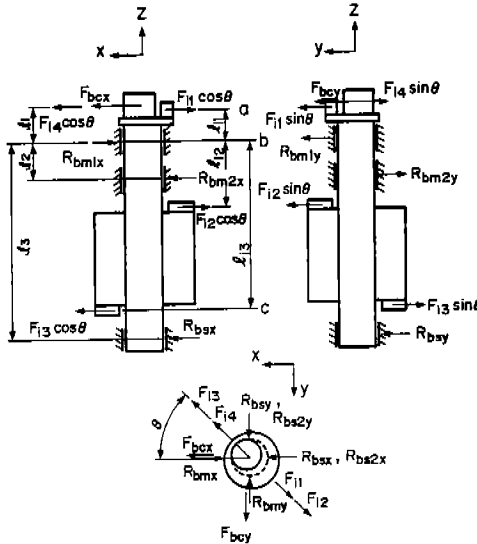

Fig.5 Analytical Model for Shaft

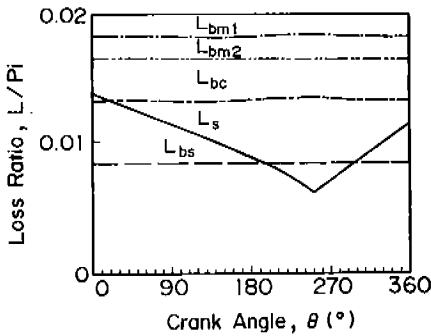

Fig.6 Calculated Losses

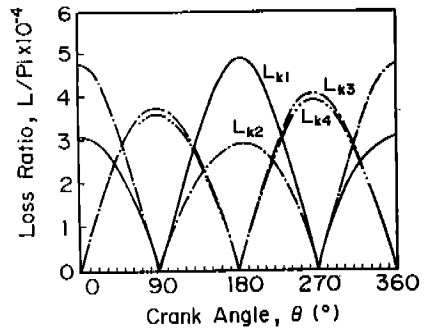

Fig.7 Calculated Key Losses

Table 1. Calculated Frictional Losses

No.	Location	Loss/Pi* (%)
1.	Shaft and upper main bearing	1.900
	Shaft and lower main bearing	1.745
2.	Shaft and crank bearing	1.367
3.	Shaft and sub-bearing	0.895
4.	Orbiting and fixed scroll	1.045
5.	Oldham coupling keys and key ways	0.082
6.	Shaft and frame	0.095
7.	Rotor end and refrigerant gas	0.005
8.	Oil pump in shaft	0.005
9.	Shaft and oil	0.020
10.	Oldham coupling and frame	0.000
Total		7.16

\* Pi Input power of compressor

Table 2. Experimental Results

Factor	Loss/Pi <sup>M</sup> (%)
Isentropic work	63.2
Over-compression loss	1.1
Wiredrawing loss	0.0
Reakage loss and heat loss	15.0
Motor loss	13.0
Sum of frictional losses	7.7
TOTAL	100.0%

\* Pi: Input power of compressor

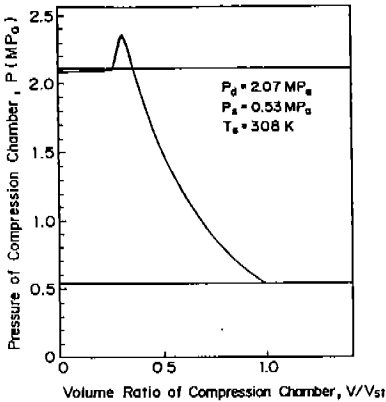

Fig.8 Indicator Diagram

Table 3 Consumption Power in Rotary Compressor from [9]

Isentropic work	61.7%
Leakage loss	5.7%
Wiredrawing loss	1.3%
Over-compression loss	1.5%
Reexpansion loss	4.3%
Crank bearing loss	2.8%
Journal bearing loss	2.4%
Thrust bearing loss	1.4%
Blade loss	0.5%
Windage loss	1.4%
Motor loss	16.0%
Unknown loss	1.0%
TOTAL	100.0%