

1984

An Experimental Study of the Shaft Oil Supply Mechanism of a Rotary Compressor

H. Asanuma

T. Itami

H. Ishikawa

Follow this and additional works at: <https://docs.lib.purdue.edu/icec>

Asanuma, H.; Itami, T.; and Ishikawa, H., "An Experimental Study of the Shaft Oil Supply Mechanism of a Rotary Compressor" (1984). *International Compressor Engineering Conference*. Paper 478.
<https://docs.lib.purdue.edu/icec/478>

This document has been made available through Purdue e-Pubs, a service of the Purdue University Libraries. Please contact epubs@purdue.edu for additional information.

Complete proceedings may be acquired in print and on CD-ROM directly from the Ray W. Herrick Laboratories at <https://engineering.purdue.edu/Herrick/Events/orderlit.html>

AN EXPERIMENTAL STUDY OF THE SHAFT OIL SUPPLY MECHANISM
OF A ROTARY COMPRESSOR

Hajime ASANUMA, Tsugio ITAMI, Haruo ISHIKAWA

TOSHIBA CORPORATION, FUJI WORKS

336 Tadehara, Fuji City, Shizuoka Prefecture, Japan, 416

ABSTRACT

This paper describes the experimental study of the shaft oil feed mechanism of a rotary compressor. The oil contained in the shaft in which an oil pump is inserted is fed to the respective sliding surfaces of the subbearing section, eccentric section and main bearing section of the shaft by centrifugal force of shaft rotation. The oil feed pressure of shaft rotation is approximately 0.1 kg/cm^2 . In addition, the oil slot of the main bearing acts as a viscous pump and its oil feed capacity is only a fraction of the capacity of the shaft. In a compressor, oil is forced to the respective sliding surfaces by the centrifugal oil feed pressure of the shaft. The oil slots of the subbearing section, eccentric section and main bearing section of the shaft, and the clearances between the sliding surfaces of the compression chamber act as resistance to the oil flow. If oil leakage into the compression chamber is excessively large, the amount of oil fed to other sliding surfaces will decrease. Therefore, the amount of oil leakage into the compression chamber must be considered in regard to the oil feed capacity of the shaft.

INTRODUCTION

A rotary compressor is characterized by its small size, light weight, low cost, high performance and high reliability and has been generally utilized for household air conditioners.

The high performance and high reliability of a rotary compressor greatly depends on the oil feed performance of the shaft. If an excessively small amount of shaft oil feed is fed, it will cause insufficient oil sealing of the compression chamber and heavy metal contact. If the amount of shaft oil feed is excessively large, the discharge of oil from the compressor housing will increase and the oil level in the compressor housing will be reduced.

However, very few studies regarding such shaft oil feed have been carried out. The principal aims of this paper are as follows:

- A. To theoretical and experimentally clarify the oil feed characteristics of the shaft and main bearing under the nonload pneumatic operating condition and
- B. To theoretical and experimentally clarify the oil feed characteristics of the main bearing under dynamic condition of a assembled compressor

FEATURES OF A ROTARY COMPRESSOR

Structure

In a hermetic rotary compressor, the motor drive unit is located at the top of the shell and the compression mechanism unit is located on the bottom of the shell. These two units are fixed directly to the shell and the respective rotary portions of each are connected together by the shaft. The lubricating oil charged in the bottom of the shell flows in the shaft lower end and is fed through the oil path to the sliding surfaces and sealing portions of the compression mechanism.

A roller is mounted on the eccentric section of the shaft and rotates at the center of the cylinder. A suction pipe is directly inserted into the suction chamber, and compressed gas at high-temperature and high-pressure is discharged once into the shell.

Features

A. High Performance

Suction action and compression action are performed simultaneously and very smoothly. In addition, since suction gas flows directly in the suction chamber without a suction valve and suction muffler, wire-drawing, re-expansion and superheat during a suction process are very small, and

over-compression during a discharge process is also small. Accordingly, high performance and high efficiency are displayed.

B. High Side Shell (Case High Pressure Type)

Both lubrication of the compression chamber sliding surfaces and sealing of compressed gas are performed sufficiently with a simple structure because the inside of the shell is maintained at high pressure. The oil fed to the sliding surfaces of the eccentric section of the shaft by the shaft oil feed mechanism described in this paper is forced between the clearances at the compression chamber sliding surfaces by the differential pressure between the pressure in the shell and the pressure in the compression chamber and suction chamber. Accordingly, the volumetric efficiency of the compression mechanism is very high. Additionally, the compressed gas is discharged once in the shell, maintains the inside of the shell at high pressure and then is discharged to the outside of the shell. This provides easy separation of oil in the compressed gas.

C. Small Size and Light Weight

Since the mechanical unbalance of a rotary compressor is small, the motor and compression mechanism are mounted directly on the shell. Moreover, the components of the compression mechanism are few in number and small in size. So, a rotary compressor is of small size and light weight construction.

EXPERIMENTAL AND THEORETICAL ANALYSIS

Shaft Oil Feed Characteristic under Nonload Pneumatic Operating Condition

A. Theoretical Analysis

A sectional view of the shaft end in which the oil pump is inserted is shown in Fig. 2. The oil in the shaft is forced through holes 1, 2 and 3 by centrifugal force due to shaft rotation and is fed to the respective sliding surfaces of the subbearing section, eccentric section and main bearing section of the shaft. The oil in the shaft is regarded as forced vortex motion at the same angular velocity as that of the shaft. Rotation of the circular cylinder around its axis is shown in Fig. 3. The head of paraboloid of revolution is expressed by the following equation.

$$H = \frac{\omega^2 R^2}{2g} \quad (1)$$

The pressure head of the oil at the holes

opened to the respective sliding surfaces is:

$$h = \frac{\omega^2}{2g} (R_s^2 - R_o^2) \quad (2)$$

The amount of the lubricating oil forced out of the holes is expressed by the following equation.

$$Q_f = C.A.h\sqrt{2ghf} \quad (3)$$

Where,

$$hf = \frac{\omega^2}{2g} (R_{si}^2 - R_o^2) \quad (4)$$

B. Experimental Analysis

The method of measuring h in equation (2) is shown in Fig. 4. The shaft without an eccentric section was utilized and the roller was fixed on the subbearing so that it would be concentric with the shaft. A gap was provided between the roller inner surface and the shaft, and a vent hole was made in the main bearing. The pressure head due to shaft rotation is expressed by equation (2). When obtaining h of equation (2) in Fig. 4, one factor must be considered. The factor is the increment of pressure head because the oil in the roller is rotated by the shaft. This increment of pressure head can be obtained by solving the problem that the inner cylinder rotates and the outer cylinder rests. The expression of velocity distribution is as follows.

$$w = \frac{\omega R_s^2}{R_{ri}^2 - R_s^2} \left(\frac{R_{ri}^2}{r} - r \right)$$

The pressure P_i acting on the oil layer outside and adjacent to element dS in Fig. 6 is expressed by:

$$P_i = \rho \omega^2 \frac{dr}{r}$$

Therefore, the increment of pressure head in this experiment is as follows.

$$h_i = \int_{R_s}^{R_{ri}} \frac{w^2}{g} \frac{dr}{r}$$

$$= \frac{1}{g} \left(\frac{\omega R_s^2}{R_{ri}^2 - R_s^2} \right)^2 \int_{R_s}^{R_{ri}} \left(\frac{R_{ri}^2}{r} - r \right)^2 \frac{dr}{r} \quad (5)$$

The pressure head measured according to the method utilized in this experiment is expressed by:

$$h_e = h + h_i \quad (6)$$

The method of measuring flow is shown in Fig. 7. This measurement system is about the same as the pressure head measurement

system, but is different from the pressure head measurement system in that no roller and no vent hole are provided. The oil spouting out of the oil feed hole of the shaft is gathered in the female cylinder through the wide outlet.

C. Results

To obtain h of equation (2), R_o is required. However, it is difficult to catch the influence of the oil pump inserted at the shaft lower end as a numeral value. First, h of equation (2) was obtained according to equation (6) and R_o was calculated according to equation (2). The method of calculating R_o is shown in Fig. 8. R_o obtained from the results of the experiment is not zero, but larger than zero. This shows that the oil in the shaft takes the shape of a paraboloid of revolution.

Flow Q_f is calculated by utilizing R_o . Where, $C = 0.5$ because the inlet of the shaft oil feed hole has an edge. The comparison of calculated and experimental flow values of the lubricating oil due to shaft rotation is shown in Table 2. The results of calculation coincides well with that of the experiment.

Oil Feed Characteristic of Main Bearing under Nonload Pneumatic Operating Condition

A. Theoretical Analysis

A spiral oil slot whose sectional view is a half circle is provided at the inner circumference of the main bearing. Accordingly, three forces act on the lubricating oil in the oil slot as the shaft rotates. One is the action force of the viscous pump due to the spiral oil slot and the others are actions of the pressure and velocity of oil spouting from the shaft oil feed hole. The viscous pump and oil pressure action are examined in this section.

First, regarding the viscous pump action, the flow is as follows because the diameter portion of the half circle moves.

$$Q_{vp} = \frac{U a^2}{2} \quad (7)$$

Where, $U = 2\pi R_s f \cos\theta$

Next, the flow with consideration of the pressure head due to oil rotation with the shaft is expressed by:

$$Q_p = \frac{\pi a^4}{8\mu} \cdot \frac{P}{l} \cdot F \quad (8)$$

Where, $F = 0.18958$

The total flow in the main bearing oil slot is as follows.

$$Q_o = Q_{vp} + Q_p \quad (9)$$

B. Experimental Analysis

The experimental system is shown in Fig. 9. The hollow portions of the shaft were all plugged, the shaft without an eccentric section was utilized, the cylinder was filled with lubricating oil and the roller was removed. All the oil flowing out of the main bearing oil slot was gathered and poured into the female cylinder. An experiment was performed with lubricating oil of two types of viscosity; 7 cP and 20 cP. The dimensions of the spiral oil slot utilized in this experiment is as follows:

Radius of Section: $a = 0.8$ mm

Length: $l = 50$ mm

Angle of Gradient: $\alpha = 68.5^\circ$

C. Results

Fig. 11 and Fig. 12 show the results of calculation and this experiment. Concerning the viscous pump effect due to shaft rotation, the experimental value of the flow of lubricating oil was slightly smaller than the calculated value. This tendency appeared in oil with a viscosity of both 7 cP and 20 cP.

In the case where the pressure is applied without rotating the shaft, the experimental value coincided well with the calculated value.

On the other hand, the flow of lubricating oil in viscosity of 20 cP with the shaft rotated and with pressure applied showed that equation (9) is nearly exacted (superposition holds). However, concerning the flow of lubricating oil in viscosity of 7 cP, the viscous pump action shows a tendency to decrease as the flow of oil increases. This is expressed by Reynold's number:

$$Re = \frac{U' \cdot a}{\nu}$$

Where,

U' = flow speed of oil within oil slot

If $Re \leq 32$, equation (9) holds. However, if $Re \geq 112$, equation (9) does not hold and the flow of oil is expressed by equation (8).

Oil Feed Characteristic of the Main Bearing of an Assembled Compressor under Dynamic Condition

A. Theoretical Analysis

Since pressure differential occurs between the inner circumference and outer circumference of a roller in a compressor under dynamic condition, the leakage of

lubricating oil into the compression chamber and suction chamber due to the clearance of height between the cylinder and roller must be considered. If the amount of the leakage is excessively large, the amount of lubricating oil fed to the subbearing and main bearing will decrease. This point requires attention. Generally, the amount of oil leakage Q_l is expressed by the following equation:

$$Q_l = \frac{\pi \delta^3 P_m}{6 \mu \ln R_{ro}/R_{ri}} \quad (10)$$

Where,

$$P_m = \int_0^{2\pi} \frac{(2\pi - \theta)(P_d - P_c) + \theta(P_d - P_s)}{2\pi} d\theta$$

On the other hand, the pressure difference P_t between the inlet and outlet of the oil slot is expressed as follows.

$$P_t = \rho(g(h - l_m) + (W_s - W_o)^2)$$

Flow Q_{ms} due P_t is expressed by:

$$Q_{ms} = \frac{\pi a^4}{81\mu} \cdot P_t \cdot F \quad (11)$$

That is, flow Q_m of the lubricating oil in the main bearing oil slot is as follows.

$$Q_m = Q_{ms} + Q_{vpp} \quad (12)$$

Q_{vpp} is as follows according to the experiment described in the above paragraph.

If $Re \leq 32$, $Q_{vpp} = Q_{vp}$

If $32 < Re < 112$, $Q_{vp} > Q_{vpp} > 0$

If $Re \geq 112$, $Q_{vpp} = 0$

B. Experimental Analysis

The method of this experiment is shown in Fig. 13. Operating condition is; discharge pressure = 21 kg/cm²G, suction pressure = 5.4 kg/cm²G and suction temperature = 35 °C. Under such condition, the viscosity of compressor lubricating oil is 7 cP.

$\delta = 20 \times 10^{-4}$ cm, $R_{ro} = 2.26$ cm and $R_{ri} = 1.7$ cm were selected as dimensions relating to leakage, in order that the oil leakage due to height clearance between the cylinder and roller will be maintained to the permissible degree.

In addition, four sets of compressors whose the sectional areas of the oil slots were different from each other was prepared, and the amount of oil feed of each compressor was measured.

C. Results

First, Q_m was calculated with W_s and W_o of zero. Then, W_o was calculated by utilizing the calculated Q_m and Q_m was again

calculated by utilizing the calculated W_o . Such a calculation was performed until converged.

Fig. 14 shows the result of the calculation with the different section areas of the main bearing oil slots of four compressors, which well coincided with the result of this experiment.

CONCLUSION

1. The shaft oil feed mechanism was clarified experimentally and theoretically.
2. The maximum oil feed capacity of a shaft is several times as much as the amount of oil feed of the shaft assembled in a compressor and its feed pressure is approximately 0.1 kg/cm².
3. Under dynamic condition of a compressor, oil is forced to the respective sliding surfaces by oil feed pressure of a shaft. The oil slots of the main bearing and subbearing, and the clearances at the sliding surfaces of the compression chamber act as resistance to the oil flow.

NOMENCLATURE

a	Radius of oil slot
Ah	Cross sectional area of main bearing oil feed hole
C	Contraction coefficient of main bearing oil feed hole
f	Rotation frequency of shaft
g	Acceleration of gravity
H	Head of paraboloid of revolution
l	Length of oil slot
l _m	Length of main bearing
P	Pressure difference between inlet and outlet of oil slot
P _c	Pressure in compression chamber
P _d	Discharge pressure
P _m	Average pressure difference between inside and outside of roller
P _s	Suction pressure
Q _{vpp}	Oil flow of slot by viscosity effect
r	Radius
R	Cylinder radius
R _o	Radius of paraboloid of revolution
R _{ri}	Inner radius of roller
R _{ro}	Outer radius of roller
R _s	Shaft inner radius
W	Velocity of oil between roller and shaft
W _o	Oil flow speed in oil slot under dynamic condition

W_s Tangential speed of shaft
 θ Angle of roller rotation
 δ Leakage clearance
 ν Kinematic viscosity
 ρ Mass density
 μ Viscosity
 ω Angular velocity

REFERENCES

- (1) M. OZU, T. ITAMI, Some Electrical Observations of Metallic Contact between Lubricated Surfaces under Dynamic Conditions of Rotary Compressor, 1980 Purdue Compressor Technology Conference.
- (2) M. OZU, T. ITAMI, Efficiency Analysis of Power Consumption in Small Hermetic Refrigerant Rotary Compressors, IJR, September, 1981.
- (3) T. MATSUZAKA, S NAGATOMO, Rotary Piston Type Rotary Compressor Performance Analysis, 1982, Purdue Compressor Technology Conference.
- (4) V. L. STREETER, E. B. WYLIE, Fluid Mechanics Sixth Edition, Mcgraw-Hill.

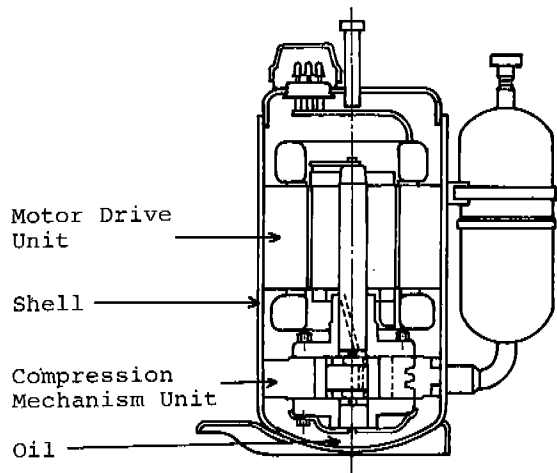

Fig. 1. Rolling Piston Type Rotary Compressor

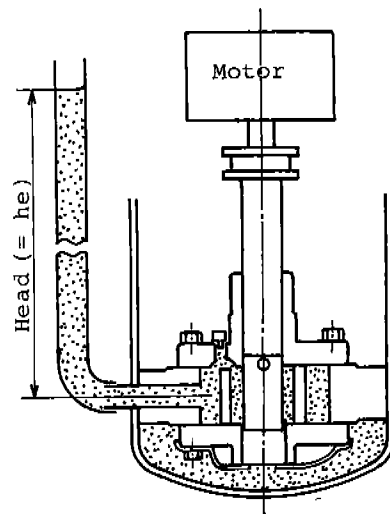

Fig. 4. Head Measurement System of the Shaft Oil Feed

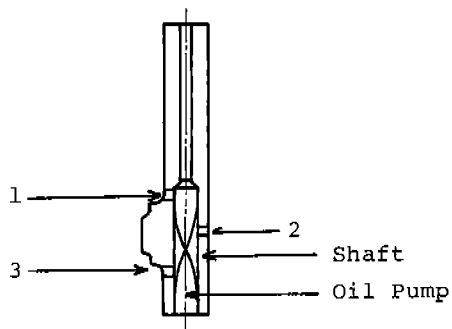

Fig. 2. Oil Feed Holes of the Shaft

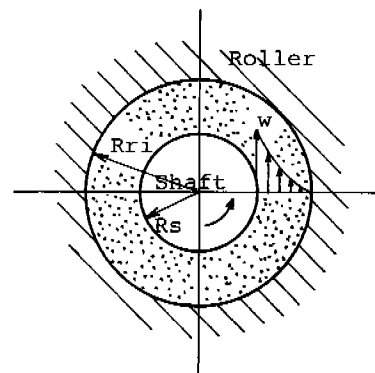

Fig. 5. Velocity Distribution of Oil between Roller and Shaft

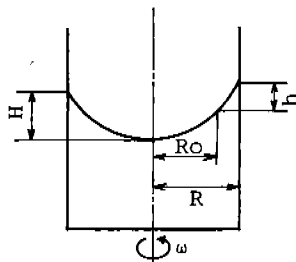

Fig. 3. Rotation of the Circular Cylinder around its Axis

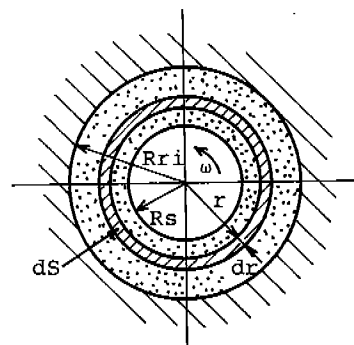

Fig. 6. Calculation of h_i Due to Shaft Rotation

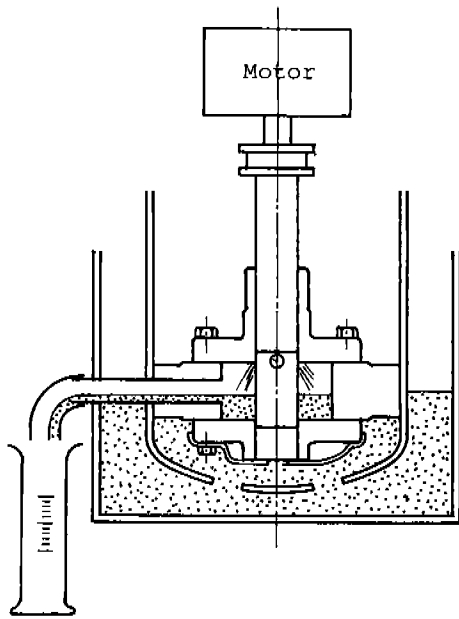

Fig. 7 Flow Measurement System of the Shaft Oil Feed

Table 1. Experimental Values h_e and Calculated Values R_o

he and Ro (cm)		
Frequency (Hz)	48	57
h_e (Experiment)	54	78
R_o (Calculation)	0.30	0.33

Table 2 Comparison of Calculation and Experiment

Q_f (cm ³ /S)		
Frequency (Hz)	48	57
Calculation (Q_f)	4.4	5.0
Experiment (Q_f)	4.1	4.5

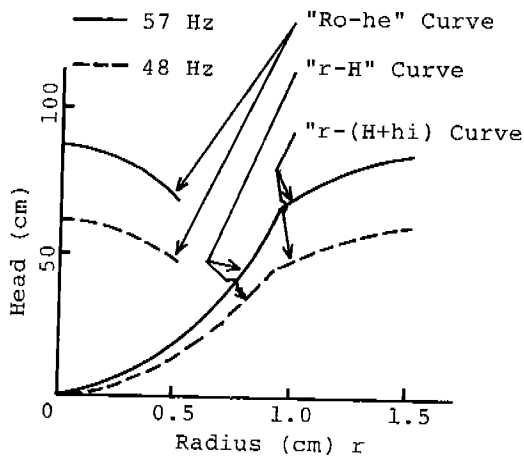

Fig. 8. Calculation of R_o by "radius-head" Diagram

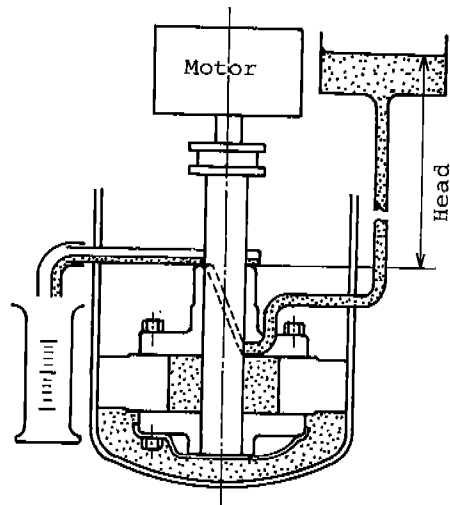

Fig. 9 Flow Measurement System of Main Bearing Oil Slot

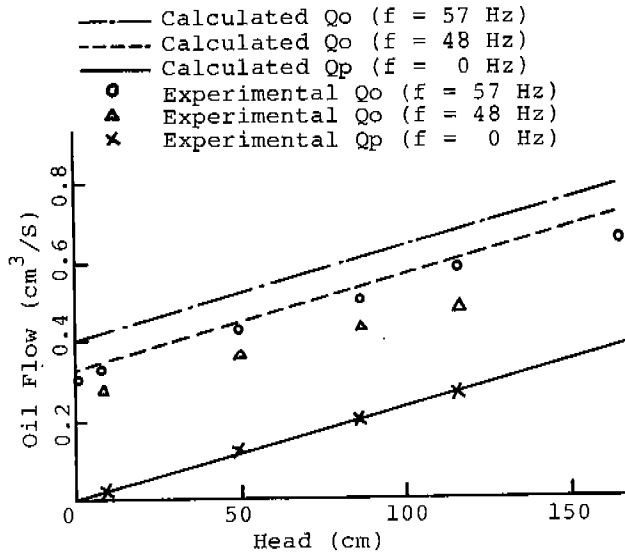

Fig. 10. Oil Feed Flow of Main Bearing Oil Slot, Viscosity = 20 cP

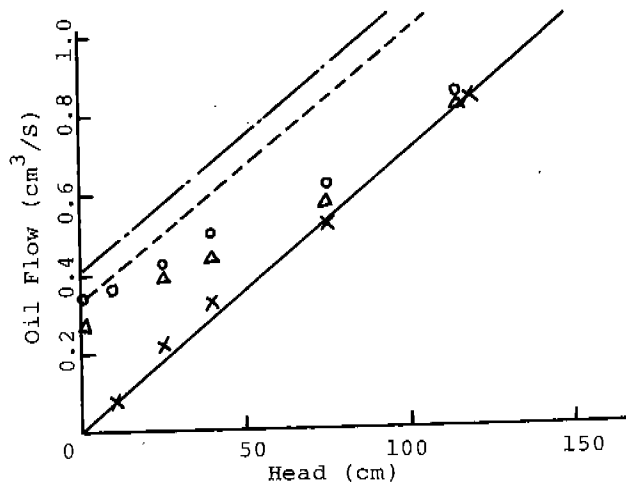

Fig. 11. Oil Feed Flow of Main Bearing Oil Slot, Viscosity = 7 cP

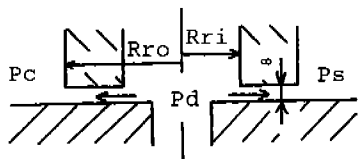

Fig. 12. Leakage from Roller

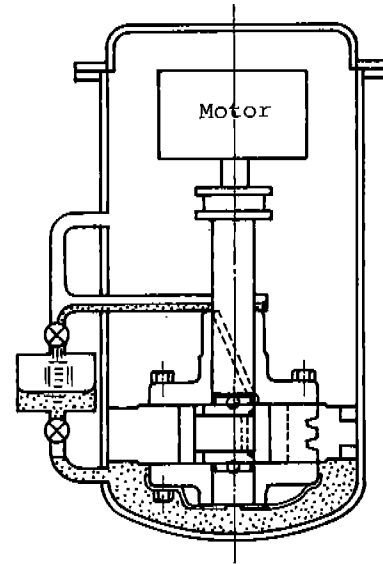

Fig. 13. Oil Flow Measuring System under Dynamic Compressor

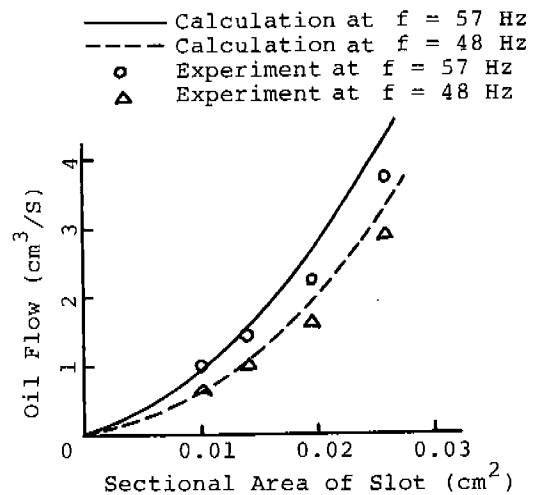

Fig. 14. Relation between Oil Slot Area and Oil Flow Under Dynamic Condition