

July 2018

# Domestic High Temperature Air Source Heat Pump: Performance Analysis Using TRNSYS Simulations

Khoa Xuan Le

*Centre for Sustainable Technologies, University of Ulster, Newtownabbey, Northern Ireland, United Kingdom, le-k@ulster.ac.uk*

Ming Jun Huang

*Centre for Sustainable Technologies, University of Ulster, Newtownabbey, Northern Ireland, United Kingdom, m.huang@ulster.ac.uk*

Neil J. Hewitt

*Centre for Sustainable Technologies, University of Ulster, Newtownabbey, Northern Ireland, United Kingdom, nj.hewitt@ulster.ac.uk*

Follow this and additional works at: <https://docs.lib.purdue.edu/ihpbc>

---

Le, Khoa Xuan; Huang, Ming Jun; and Hewitt, Neil J., "Domestic High Temperature Air Source Heat Pump: Performance Analysis Using TRNSYS Simulations" (2018). *International High Performance Buildings Conference*. Paper 315.  
<https://docs.lib.purdue.edu/ihpbc/315>

This document has been made available through Purdue e-Pubs, a service of the Purdue University Libraries. Please contact [epubs@purdue.edu](mailto:epubs@purdue.edu) for additional information.

Complete proceedings may be acquired in print and on CD-ROM directly from the Ray W. Herrick Laboratories at <https://engineering.purdue.edu/Herrick/Events/orderlit.html>

## Domestic High Temperature Air Source Heat Pump: Performance Analysis Using TRNSYS Simulations

Khoa Xuan LE<sup>1\*</sup>, Ming Jun HUANG<sup>1</sup>, Neil J. HEWITT<sup>1</sup>

<sup>1</sup>Centre for Sustainable Technologies, University of Ulster,  
Newtownabbey, Northern Ireland, United Kingdom  
Tel: +44-(0)-2890366122, Email: [le-k@ulster.ac.uk](mailto:le-k@ulster.ac.uk)

\* Corresponding Author

### ABSTRACT

The aim of this study is to analyze the annual performances of a variable capacity high temperature air source heat pump when retrofitted into a mid-terraced house in different aspects combining control, property ages and locations across the UK. TRNSYS simulations are used to predict the performances of the retrofit high temperature air source heat pump. Firstly, the heat pump model and the whole building model are developed and validated against field trial results. Then, a series of reference dwellings combining three climate conditions (Belfast, Aviemore and Camborne), three dwelling ages (the '00s, '70s and '90s) and two control strategies (fixed water flow temperature and weather compensation) is simulated. The annual simulation results indicate that the heat pump efficiency is highly affected by all three factors. The heat pump's COPs, energy consumption, running cost and carbon emissions have been discussed in this paper, which can provide good information for further studies assessing the retrofit potential of this kind of heat pump.

### 1. INTRODUCTION

Regarding domestic sector in the UK, almost 88% of space heating and hot water demand were met by using fossil fuel boilers (DECC, 2015), and they were responsible for 40% of domestic heat related emission (DECC, 2012). The recent UK's policies have encouraged the domestic sector to be more energy efficiency and renewable energy utilization in order to hit the legally binding target of reducing carbon emissions up to 80% by 2050 (PUK, 2008). Therefore, replacing existing fossil fuel boilers with alternative renewable technologies has been a considerable attention.

Air source heat pumps (ASHPs), illustrating not only a renewable-based alternative to fossil fuel boilers but also an efficient technology, are considered as a promising solution to achieve the carbon reduction target in the domestic sector. Hence, there is much research in the UK (*e.g.* Kelly and Cockroft (2011); Dunbabin and Wickins (2012)) aiming at assessing the performance of the ASHPs when retrofitted into existing dwellings where oil and gas boilers have been well established with traditional wet radiators. Most of those research focuses on the standard ASHPs of which the output water temperatures limit to 55°C, and the authors conduct this kind of heat pump with a compromise of using oversized radiators or under-floor heating because the existing traditional wet radiators cannot work efficiently with the flow temperature of under 75°C (BSI, 2014). However, those retrofit approaches requiring the modification of the heating distribution systems such as radiators, hot water tanks, piping etc. would lead to the high capital cost, and therefore it would be a barrier to encourage homeowners to replace their boilers. To mitigate this issue, high temperature air source heat pumps (HT-ASHPs) can be a potential solution because its flow temperature can reach 80°C, which is similar to the supply of boilers, so that the requirement of modification of heating distribution systems can be prevented.

Due to the advantages for retrofit of HT-ASHPs mentioned above, there are several studies concerning this kind of heat pump as a retrofit option in the UK (*e.g.* The Carbon Trust (2016); Shah and Hewitt (2015)), but most of them are carried out using experimental works in short periods and therefore it limits the full-scale investigation of performance of this heat pump type. In addition, while there are many studies describing the modeling and simulations of standard ASHPs, the investigation of modelling and simulating HT-ASHPs is still scarce. To best of our knowledge,

most of the HT-ASHP works are carried out at design level through experiments (*e.g.* Wang et al. (2009), Hewitt et al. (2011)) rather than integrated systems in buildings by means of simulations. Therefore, there is in need of modelling works for HT-ASHPs to further conduct their performances in buildings when considering different aspects and time spans such as the annual.

This paper presents the model of a variable capacity HT-ASHP coupled with a whole building model in TRNSYS 17 environment (Klein *et al.*, 2014). The aim of this study is to assess the yearly techno-economic performances of a HT-ASHP when retrofitted into a mid-terraced house in different aspects combining various dwelling ages, locations and control (fixed outlet water temperature and weather compensation strategy) across the UK. The TRNSYS models have been developed and validated based on the field trial results mentioned in the previous study (Shah and Hewitt, 2015). The investigated heat pump is a cascade variable capacity HT-ASHP with a nominal capacity of 11kW. Figure 1 depicts the schematic of the retrofit system carried out in this study.

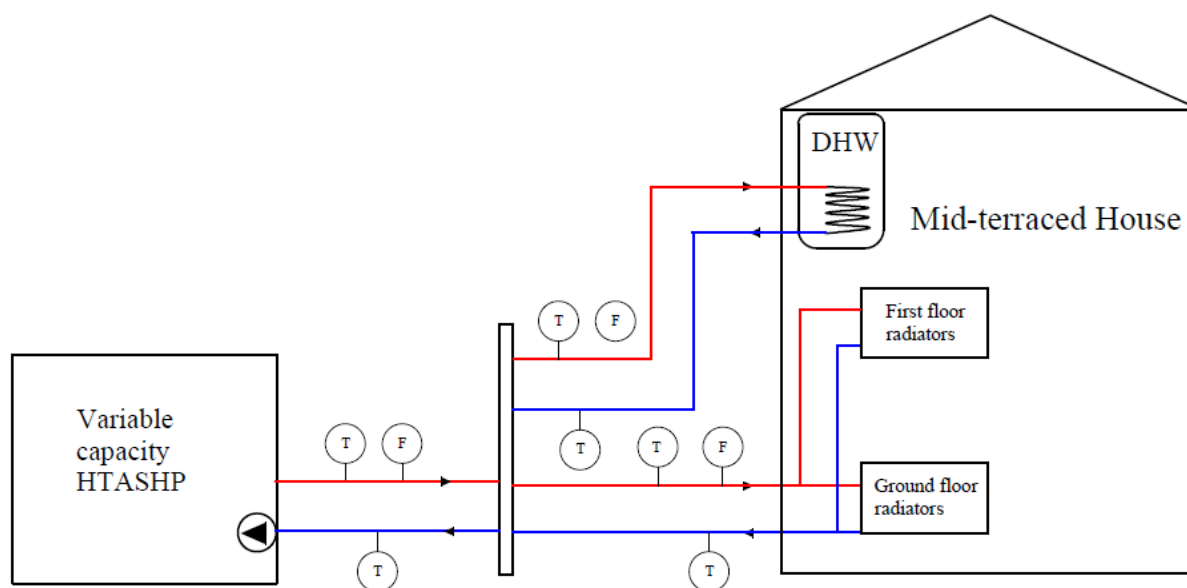

**Figure 1:** Schematic of the investigated system

## 2. TRNSYS MODEL

### 2.1 HT-ASHP model

TRNSYS Type 1231 (non-standard TESS libraries) is used to predict the performances of the variable capacity HT-ASHP. It is worth to note that this TRNSYS Type just models the steady-state performances, while it cannot predict the transient states, which is discussed more in the previous study (Le et al., 2017). This model mainly relies on a characterized performance map comprising of full load and part load curves which are obtained from field trial results (Shah and Hewitt, 2015). The performance map informed by the measured data excludes the periods of defrost operation; therefore, an incorporating defrost model is developed outside the heat pump Type 1213 model. The following subsections describe those curves and the coupling defrost model in detail.

2.1.1 Full load curves: The maximum load curves of the heat pump model are depicted in Figure 2, with the mean COP and electric power (without defrost) being illustrated as a function of external air temperature in accordance with different leaving water temperatures (LWT) at condenser side. The electric consumption of the compressors, fans, controllers and a circulating pump inside the indoor unit are totally accounted for in the performance curves.

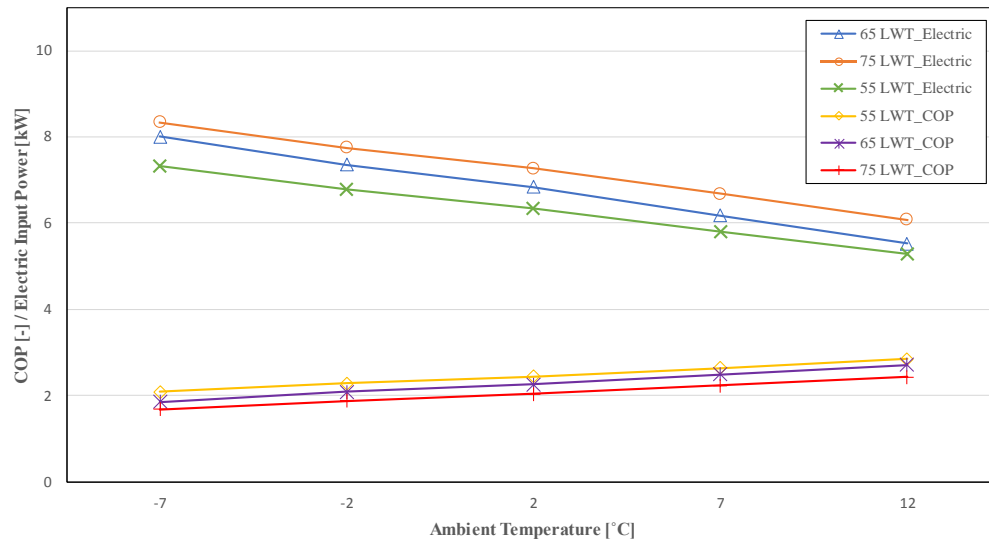

**Figure 2:** Full load curves of the heat pump model

2.1.2 Part load curves: The variable speed compressor heat pump can modulate its heat output capacity based on the thermal load required. Since part load performance highly influences the efficiency of the heat pump, its effect should be accounted for in the heat pump model. Figure 3 shows the part load curve of the model. The heat pump can reach the highest efficiency when its heat output is approximately 13kW.

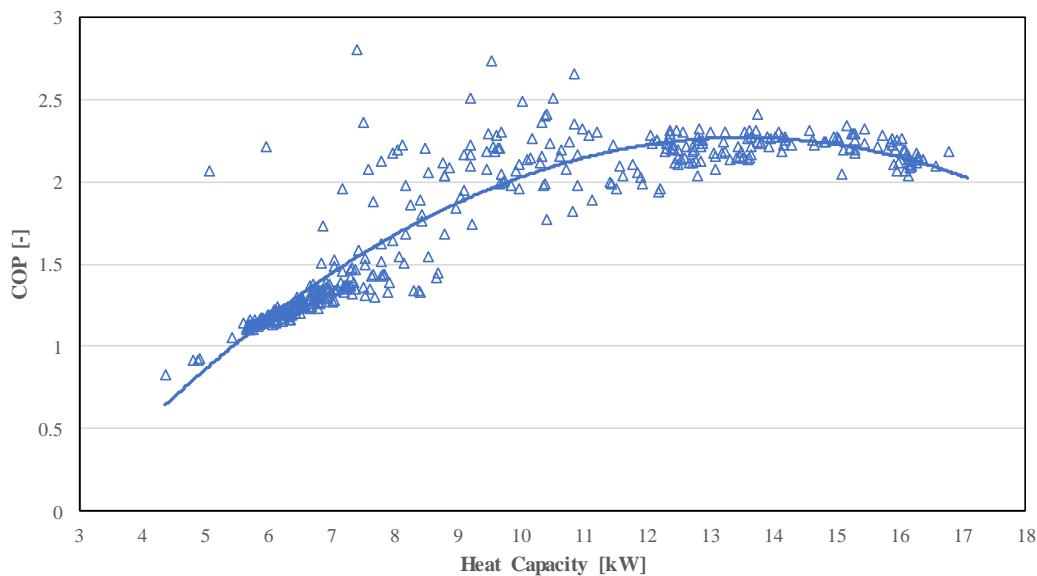

**Figure 3:** Part load curve of the heat pump when water outlet temperature is set to 76°C

2.1.3 Defrost model: The field trial data used to obtain the above full load and part load curves excludes the periods of defrost operation. Hence, a defrost model is developed outside the heat pump Type 1213 model.

The proposed defrost model is simplified using empirical correlations gained from the experimental data. When the ambient temperature is below 7°C and the relative humidity is above 65% for a long period, the heat pump activates defrost operation. The frosting time  $t_{frost}$  and the duration of a defrost cycle  $t_{def}$  are determined using the following Equation (1) and Equation (2), respectively. The time of a defrost cycle is between 1 and 10 minutes.

$$t_{frost} = 39 - 1.06T + 0.33RH + 0.13T^2 - 0.0093RH^2 - 0.018T^3 - 0.00006RH^3 \quad (1)$$

$$t_{def} = 56.2 - 0.34T - 3.56t_{frost} - 0.047T^2 + 0.079t_{frost}^2 + 0.0096T^3 - 0.00057t_{frost}^3 \quad (2)$$

The cooling energy  $E_c$  and electric consumption  $E_e$  required for a defrost cycle are expressed in Equation (3) and Equation (4). The  $Q_{c,mean}$  and  $W_{c,mean}$  equal 2.17 kW and 1.75 kW, respectively

$$E_c = \frac{t_{def} \cdot Q_{c,mean}}{60} \quad (3)$$

$$E_e = \frac{t_{def} \cdot W_{c,mean}}{60} \quad (4)$$

## 2.2 Building model

To model the mid-terraced house, Sketchup software is utilized to draw the building geometry (Figure 4), and then it is imported into TRNSYS Type 56. This building was built under the 1900s specifications, representing the popular type of housing stock (27.3%) across Northern Ireland, the UK (NIHCS, 2016). The external walls are of solid wall and loft insulation with the U-value of 1.64 W/m<sup>2</sup>K. The U-values of floors, roofs, and windows are 0.67 W/m<sup>2</sup>K, 1.42 W/m<sup>2</sup>K and 4.8 W/m<sup>2</sup>K, respectively. Infiltration is approximately 1 air changes per hour (Davies, 2016). The heat gains from occupants and equipment for the building model are estimated based on the surveys with the people who are occupying the field trial house.

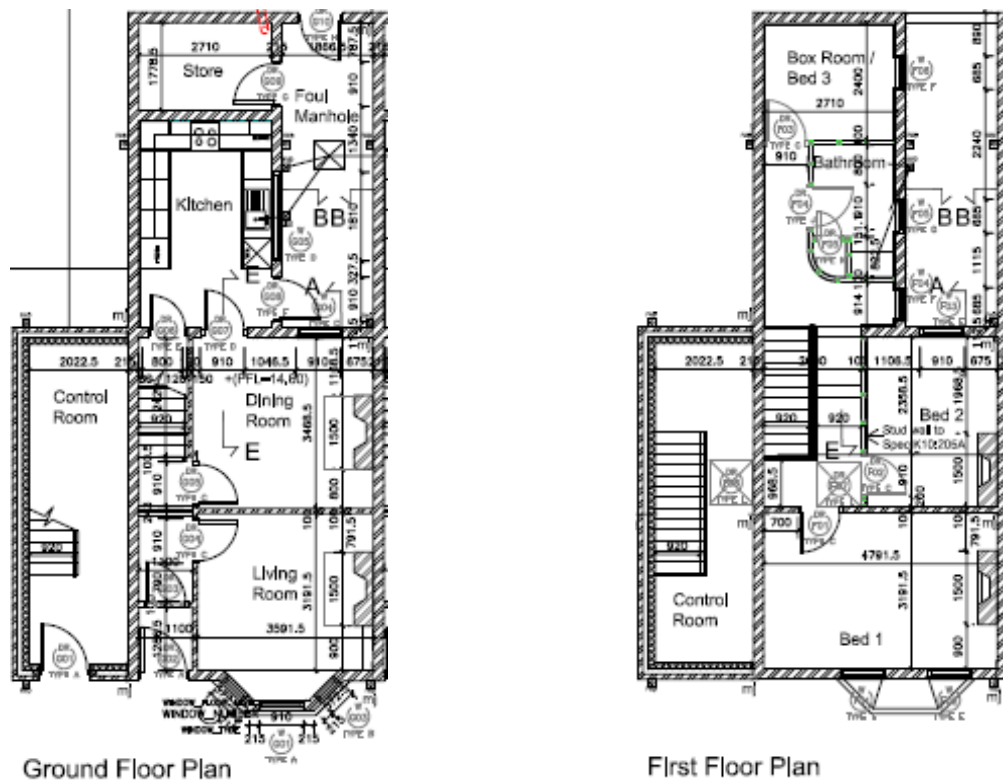

Figure 4: Mid-terraced house plans

## 2.3 Domestic hot water model

TRNSYS Type 534 is used to model the domestic hot water (DHW) tank. The DHW has a capacity of 163 liters, and its standby loss is of 2.74 kWh/day. The DHW tank is serviced by the heat pump via an internal heat exchanger coil

to maintain the hot water temperatures. The hot water drawing patterns of the DHW model are the same as the field trial results.

## 2.4 Whole system model

The HT-ASHP model, building model and DHW model above are integrated with other TRNSYS component models to compose a whole system, as illustrated in Figure 5. The heating distribution system includes radiators (Type 1231), valves (Type 11 and Type 647), piping (Type 31), temperature sensors (Type 911). Type 15 is utilized to model the weather data.

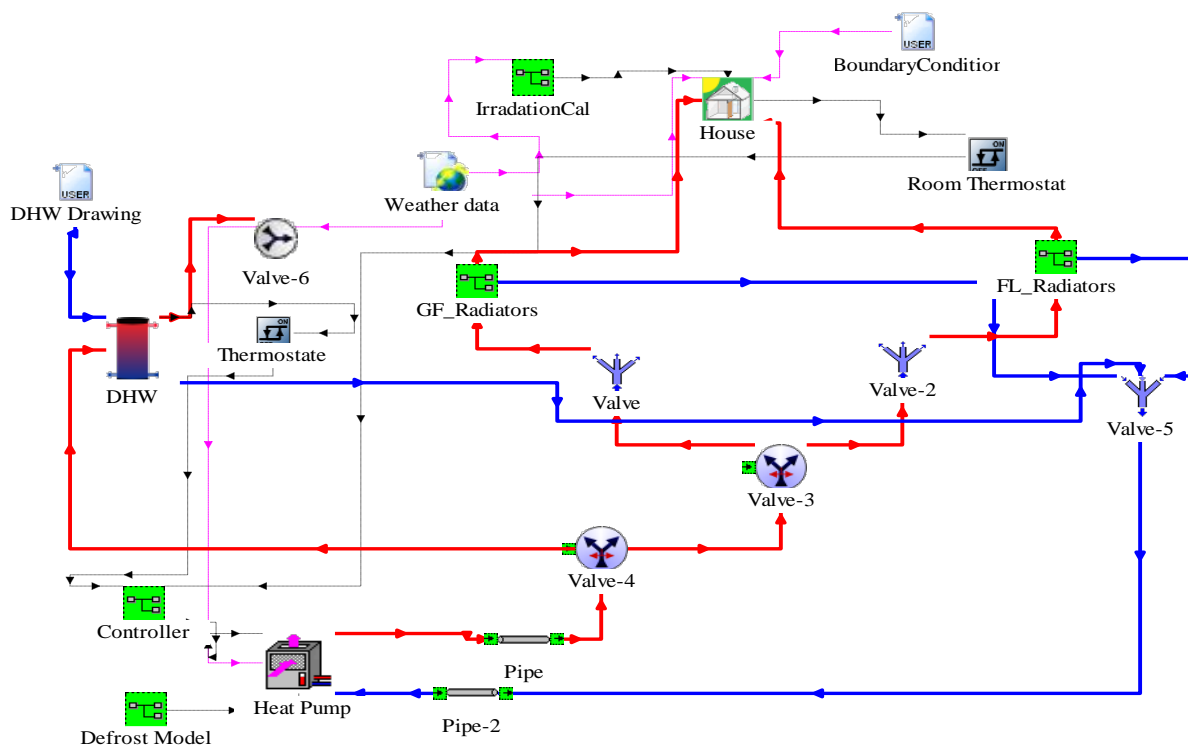

**Figure 5:** Schematic of the whole system model in TRNSYS 17 Studio

The heating system operates from 7.am to 11.pm every day observed from the monitoring data, and thus the heat pump model is also controlled on/off during that time. The temperatures within the dining room are maintained between 19.5°C and 21.5°C. The DHW tank is maintained at 60°C with a dead band of  $\pm 1^\circ\text{C}$ . The flow temperatures from the heat pump to the radiators are fixed to 76°C which is the same as the field trial one (Shah and Hewitt, 2015).

## 3. EXPERIMENTAL VALIDATION OF TRNSYS MODEL

To validate the developed models, the whole system model above is simulated and calibrated where necessary. The weather data used for calibration and validation is the real data obtained from on-site measurement. The models are simulated with 1-minute time step.

In Figure 6, the simulation's predictions for the daily COPs of the heat pump model is compared with the field trial results (Shah and Hewitt, 2015). It can be seen from the figure that the daily COPs of the model highly fall within the uncertainty ranges of the experimental COPs ( $\pm 5.59\%$ ), except some outliers respective to the measurement due to sensor malfunctions. It is noted that there is a total of 76 days (from 26/11/2014 to 10/02/2015) in which the field trial mentioned in this study was carried out.

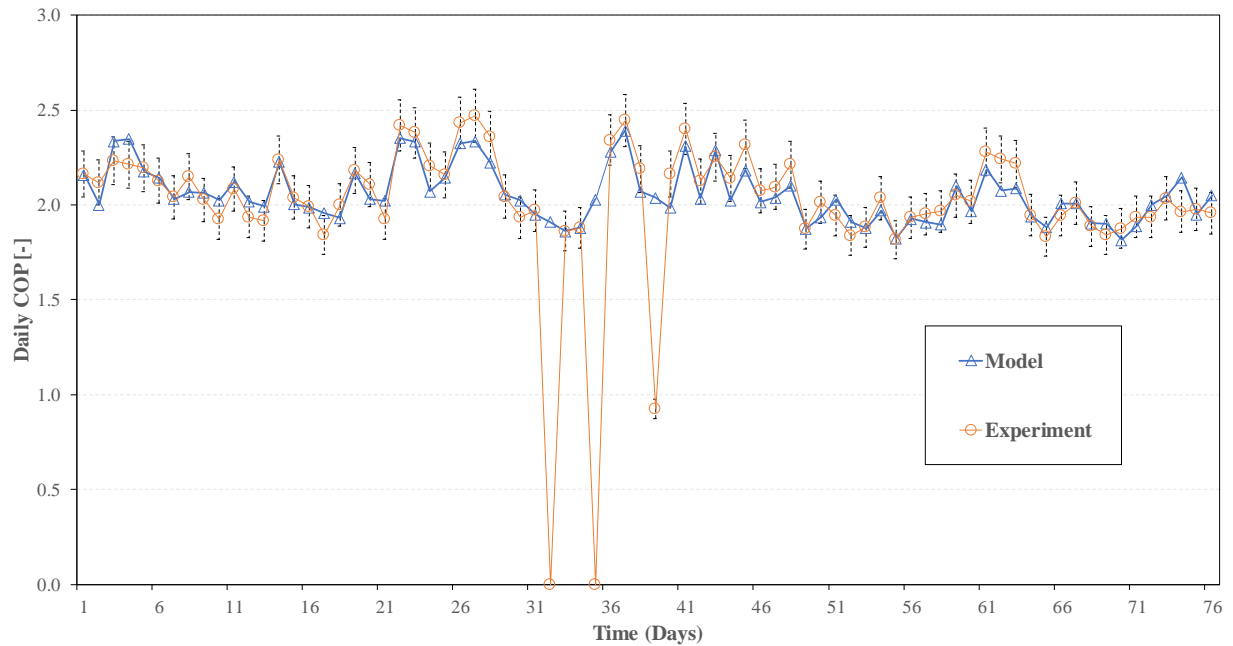

**Figure 6:** Daily COP comparison between heat pump model and field trial results in 76 days (from 26/11/2014 to 10/02/2015).

In Figure 7, the simulation's predictions for the space heating and DHW demand are compared with the house heat demand (space heating and DHW) of the field trial data. The regression line of the model relatively correlates with the one of the measurement, indicating that the whole house model can be a good test bed for conducting further simulations.

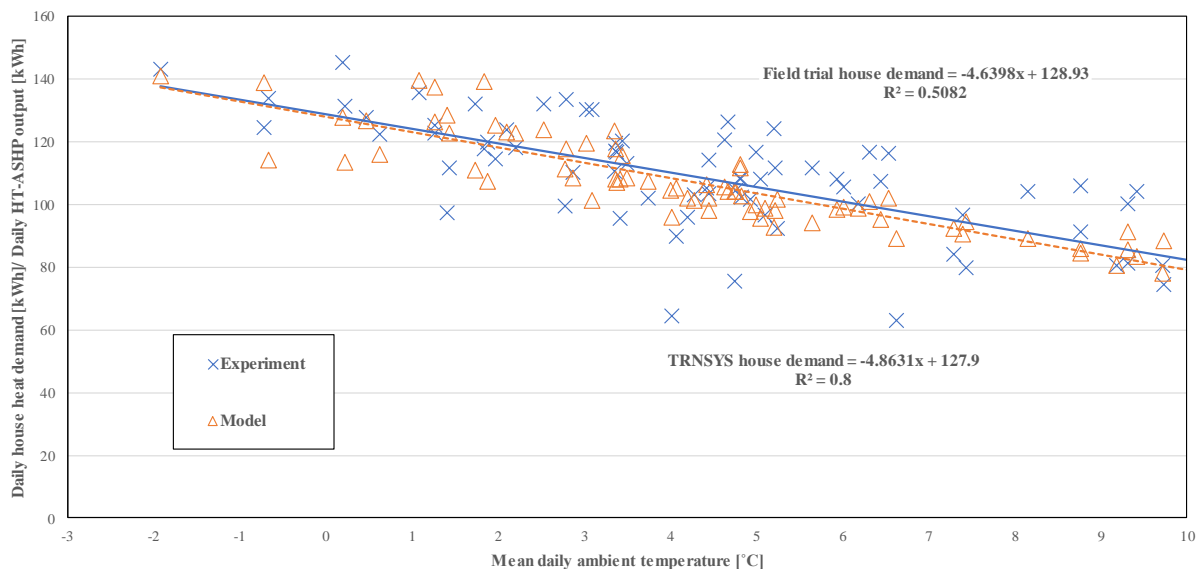

**Figure 7:** Comparison between TRNSYS model and field trial data of daily house heat demand (space heating and DHW)/ daily heat output from the heat pump.

## 4. METHODOLOGY

This paper aims at assessing the annual performances of the HT-ASHP when retrofitted into a mid-terraced dwelling in terms of different contexts combining house ages, locations and control. Therefore, a set of simulations is undertaken using the above validated models.

Considering the dwelling ages, apart from the mid-terraced house which was built under the 1900s specifications mentioned in the above section, two more fabric configurations representative of the '70s and '90s built houses are investigated. Table 1 reports the summary thermal characteristics of the three reference buildings.

**Table 1:** Thermal characteristics of three simulated buildings (Energy Saving Trust, 2005)

House age	External wall <i>U-value</i> (W/m <sup>2</sup> K)	Roof <i>U-value</i> (W/m <sup>2</sup> K)	Floor <i>U-value</i> (W/m <sup>2</sup> K)	Window <i>U-value</i> (W/m <sup>2</sup> K)	Infiltration <i>Air changes per hour</i>
1900s	1.64	1.42	0.67	4.8	1
1970s	1	0.68	0.6	4.8	1
1990s	0.55	0.35	0.45	4.8	0.5

As for the effect of climatic conditions, the reference buildings are simulated interchangeably with three different weather profiles available in TRNSYS libraries. The selected climates are of three locations across the UK including Belfast, Aviemore and Camborne. Aviemore has severe weather with the heating degree days (HDDs) of 3203, whereas Belfast (2475 HDDs) is milder following by Camborne (HDDs of 1840) where is mildest. It is noted that the base temperature of 15.5°C is used to calculate the HDDs.

Regarding the control, the heat pump model is simulated with fixed water flow temperature (76°C) and weather compensation strategy. The minimum flow temperature regarding the weather compensation control is set at 55°C if the ambient temperature is 15°C and above, while the maximum flow is set at 76°C corresponding to the ambient temperature of 0°C and below. Although the set-up for the flow temperature regarding weather compensation control could reduce the radiators' efficiency, the purpose of this is to provide a wider view of the retrofit HT-ASHP's performance.

## 5. RESULTS AND DISCUSSION

### 5.1 Annual COP

Climatic conditions highly influence the annual performance of the retrofit HT-ASHP. Aviemore, where is most severe, has the lowest yearly COPs which are about 2.03 for the fixed flow temperature and from 2.15 to 2.24 for the weather compensation strategy (Table 2). In contrast, Camborne where is the warmest location accounts for the annual COPs of about 9.9% and 18.6% higher than the ones in Aviemore in terms of fixed flow temperature and weather compensation, respectively. The HDDs of Belfast are lower than those of Aviemore but higher than those of Camborne, so the heat pump efficiency is higher in Belfast than in Aviemore but lower than in Camborne.

The building ages have another effect on the annual COPs of the heat pump. If the heat pump is retrofitted in the newer dwellings, its efficiency is reduced (see Table 2), and vice versa. This is because the better house inertia tends to make the heat pump working at lower loads.

Weather compensation control has a strongly effect on the heat pump performance. In Belfast, the annual COP improvement of the heat pump employed weather compensation control compared to the one with fixed flow temperature is between 9.4% and 14.1%. The heat pump in Aviemore accounts for the enhancement from 5.9% to 9.8%, while the improvement of maximum 19.2% can be obtained in Camborne.



**Table 2:** Summary results of simulated annual COP and electric consumption

Location	Age of house	Annual COP [-]		Annual electric use [kWh]	
		Fixed flow temperature	Weather compensation	Fixed flow temperature	Weather compensation
Belfast	1900s	2.13	2.43	11679	10049
	1970s	2.12	2.36	9163	7946
	1990s	2.12	2.32	7196	6271
Aviemore	1900s	2.04	2.24	13951	12678
	1970s	2.03	2.21	12774	11663
	1990s	2.03	2.15	8828	8113
Camborne	1900s	2.24	2.67	9412	7577
	1970s	2.23	2.62	8518	6899
	1990s	2.22	2.53	5583	4549

## 5.2 Electric consumption, running cost and carbon emissions

The annual electric use is reported in Table 2 and illustrated in Figure 8. As expected, the heat pump in Aviemore consumes the highest energy due to the severe weather, while the one in Camborne uses the lowest electricity thanks to the milder climate. Additionally, the 1900s built houses account for the highest energy utilization, whilst the buildings of the '90s consume the least energy thanks to the lower heat loss. Also, the heat pump employed weather compensation can reduce the energy use up to 19.5% compared to the one with fixed outlet water temperature.

Based on the annual electric consumption, the running cost and carbon emissions of the retrofit HT-ASHP are quantified, as reported in Table 3. The electric price of 14.83 p/kWh observed in 2017 (Power NI, 2017) is used to calculate the running cost, and the carbon conversion factor of 0.333 kgCO<sub>2</sub>/kWh (DBEIS, 2017) for grid electricity is utilized to compute the annual CO<sub>2</sub> emissions.

The highest yearly cost of £2069 and carbon emissions of 4646kg are accounted for the heat pump with fixed flow temperature retrofitted into the houses of the 1900s in Aviemore. In contrast, the retrofit HT-ASHP employed weather compensation control according to the 1990 build houses in Camborne constitutes the lowest cost of £675/year and the lowest carbon emissions of 1515kg/year.

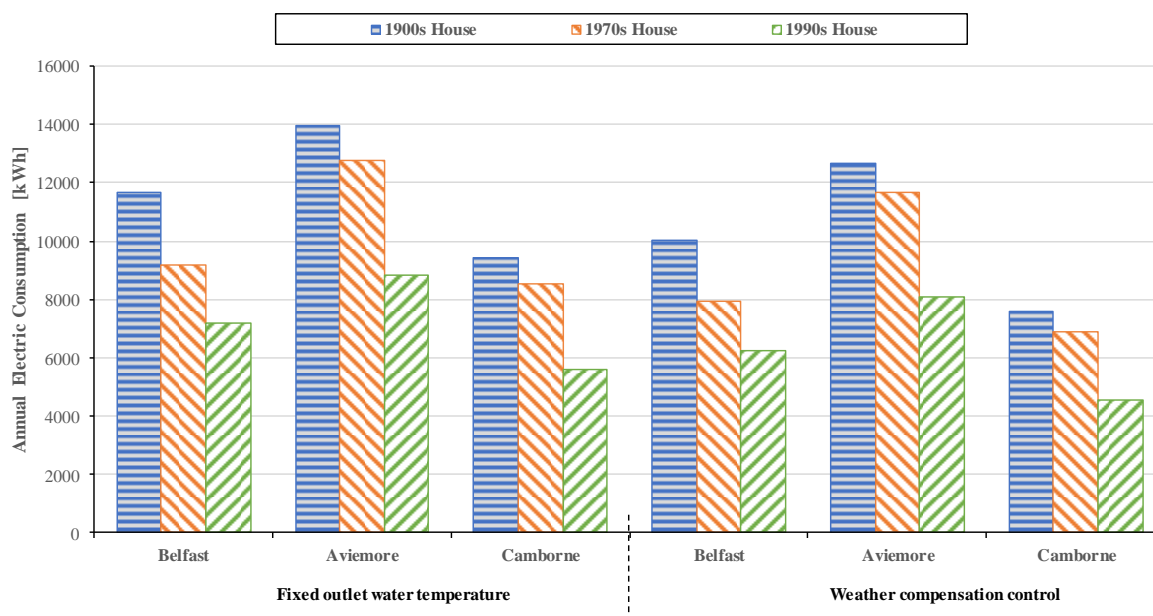
**Figure 8:** Simulation results of annual energy consumption

**Table 3:** Running cost and carbon emissions results for three different house ages and locations across the UK

Location	Age of house	Annual cost [£]		Annual carbon emissions [kg]	
		Fixed flow temperature	Weather compensation	Fixed flow temperature	Weather compensation
Belfast	1900s	1732	1490	3889	3346
	1970s	1359	1178	3051	2646
	1990s	1067	930	2396	2088
Aviemore	1900s	2069	1880	4646	4222
	1970s	1894	1730	4254	3884
	1990s	1309	1203	2940	2702
Camborne	1900s	1396	1124	3134	2523
	1970s	1263	1023	2837	2297
	1990s	828	675	1859	1515

## 6. CONCLUSIONS

The developed and validated TRNSYS models have been used to analyze the annual performances of a variable capacity high temperature ASHP when retrofitted into a mid-terrace house in various contexts including dwelling ages, locations and control. The outcomes of the simulations indicate that all three factors have strong influences on the heat pump performance:

- If the heat pump operates in the severe climates, its efficiency will reduce, leading to the rise of running cost. In contrast, the efficiency will increase if the heat pump runs in the warmer locations, resulting in lower running cost.
- Newer buildings cause the decrease of COPs because the heat pump tends to work at lower loads, but more energy, cost and carbon savings can be acquired thanks to the lower heat loss of the modern buildings.
- Weather compensation control can help the heat pump to improve its efficiency and energy savings up to 19.2% and 19.5%, respectively, compared to the fixed water flow temperature.

The simulation results related to annual efficiency, energy consumption, running cost and carbon emissions in this paper can be a good reference for further retrofit assessment of this kind of heat pump, which can help to motivate the demand.

## NOMENCLATURE

$t$	time	(minute)
$T$	ambient temperature	(°C)
$RH$	relative humidity	(%)
$E$	energy for a defrost cycle	(kWh)
$Q$	cooling power	(kW)
$W$	electric power	(kW)

### Subscript

$frost$	frosting
$def$	defrost
$c$	cooling
$e$	electric consumption
$mean$	average

## REFERENCES

BSI. (2014). *Radiators and convectors. Test methods and rating.*

- Davies, J. (2016). Building Regulations And U-values: How have they changed? - Great Home. (n.d.). Retrieved April 30, 2018, from <http://great-home.co.uk/building-regulations-u-values-how-have-they-changed/>
- DBEIS. (2017). Green Book supplementary guidance: valuation of energy use and greenhouse gas emissions for appraisal - GOV.UK. (n.d.). Retrieved February 3, 2018, from <https://www.gov.uk/government/publications/valuation-of-energy-use-and-greenhouse-gas-emissions-for-appraisal>
- DECC. (2012). *Emission from Heat: Statistical Summary*.
- DECC. (2015). *Digest of United Kingdom Energy Statistics 2015. Digest of United Kingdom Energy Statistics (DUKES) 2015*. <https://doi.org/10.1016/B978-0-12-088759-0.00001-8>
- Dubabin, P. & Wickins, C. (2012). Detailed analysis from the first phase of the Energy Saving Trust's heat pump field trial, (3), 111. Retrieved from <https://www.gov.uk/government/publications/analysis-from-the-first-phase-of-the-energy-saving-trust-s-heat-pump-field-trial>
- Energy Saving Trust. (2005). Energy Efficiency Best Practice in Housing Northern Ireland: assessing U-values of existing housing, 1–12.
- Hewitt, N. J., Huang, M. J., Anderson, M., & Quinn, M. (2011). Advanced air source heat pumps for UK and European domestic buildings. *Applied Thermal Engineering*, 31(17–18), 3713–3719. <https://doi.org/10.1016/j.applthermaleng.2011.02.005>
- Kelly, N. J., & Cockroft, J. (2011). Analysis of retrofit air source heat pump performance: Results from detailed simulations and comparison to field trial data. *Energy and Buildings*, 43(1), 239–245. <https://doi.org/10.1016/j.enbuild.2010.09.018>
- Klein, S. A., et al. (2014). TRNSYS 17, a TRaNsient SYstem Simulation and program - vol.1. *Getting started*.
- Le, K. X., Shah, N., Huang, M. J., & Hewitt, N. J. (2017). High Temperature Air-Water Heat Pump and Energy Storage : Validation of TRNSYS Models. *Proceedings of the World Congress on Engineering and Computer Science 2017. Vol II*, 754-759.
- NIHCS. (2016). Northern Ireland House Condition Survey. *English*, (March).
- Power NI. (2017). Electricity unit and tariff rates and prices - Power NI. (n.d.). Retrieved February 3, 2018, from <https://powerni.co.uk/plan-prices/compare-our-plans/tariff-rates/>
- PUK. (2008). Climate Change Act 2008. *HM Government*, 1–103. <https://doi.org/10.1136/bmj.39469.569815.47>
- Shah, N., & Hewitt, N. (2015). High temperature heat pump operational experience as a retrofit technology in domestic sector. *EEE International Conference on Engineering, Technology and Innovation/ International Technology Management Conference (ICE/ITMC)*, 1–7. <https://doi.org/10.1109/ICE.2015.7438691>
- The Carbon Trust (2016). Evidence Gathering – Low Carbon Heating Technologies, (November), 69. Department for Business Energy & Industrial Strategy. Retrieved from [https://www.gov.uk/government/uploads/system/uploads/attachment\\_data/file/545246/Solar\\_PVT\\_FINAL\\_\\_1\\_.pdf](https://www.gov.uk/government/uploads/system/uploads/attachment_data/file/545246/Solar_PVT_FINAL__1_.pdf)
- Wang, K., Cao, F., & Xing, Z. (2009). Development and experimental validation of a high-temperature heat pump for heat recovery and building heating. *Energy and Buildings*, 41(7), 732–737. <https://doi.org/10.1016/j.enbuild.2009.02.004>

## ACKNOWLEDGEMENT

This work has been funded by Research Councils UK (RCUK) under i-STUTE project and H2020, INPATH-TES. Also, the authors are highly grateful to Dr. Nikhilkumar Shah and Christopher Wilson for their field trial data.