

1992

# Energy Efficient Gas Cooling for Two -Stage Ammonia Refrigerating Plants

R. A. Cole

*R. A. Cole and Associates*

Follow this and additional works at: <http://docs.lib.purdue.edu/iracc>

---

Cole, R. A., "Energy Efficient Gas Cooling for Two -Stage Ammonia Refrigerating Plants" (1992). *International Refrigeration and Air Conditioning Conference*. Paper 164.  
<http://docs.lib.purdue.edu/iracc/164>

This document has been made available through Purdue e-Pubs, a service of the Purdue University Libraries. Please contact [epubs@purdue.edu](mailto:epubs@purdue.edu) for additional information.

Complete proceedings may be acquired in print and on CD-ROM directly from the Ray W. Herrick Laboratories at <https://engineering.purdue.edu/Herrick/Events/orderlit.html>

# ENERGY EFFICIENT GAS COOLING FOR TWO-STAGE AMMONIA REFRIGERATING PLANTS

RONALD A. COLE  
R. A. Cole and Associates, Inc.  
Champaign, IL (USA)

## ABSTRACT

Gas and liquid coolers for two-stage refrigerating plants conventionally have been designed to submerge the discharge pipe from the low-temperature-compressor below a maintained liquid level and to bubble the gas through the liquid to effect the cooling. Excess compressor discharge head, nozzle losses and gas reheating are some of the attendant deficiencies. When the gas and liquid cooler is also used as a pump receiver for the high temperature loads in the plant, additional problems such as oil management and promotion of pump cavitation additionally occur.

By using the pump by-pass flow to cool the gas in the pipe ahead of the receiver, improvements in compressor efficiency and reduced refrigerant inventory is accomplished.

## INTRODUCTION

The design for gas and liquid coolers (GLC's) for large two-stage refrigerating plants has been one of accepted convention for many decades. Typically two types of gas and liquid coolers have been employed; namely, the flash type intercooler as shown in Figure 1 and the high pressure liquid subcooler type as shown in Figure 2. Both types employ a submerged low-pressure-compressor (booster) discharge gas pipe below a maintained liquid level to cause the mixing of the gas with the liquid as the gas bubbles rise to the surface to cool the gas.

The primary functions of these vessel are basically two: first, cool the booster discharge gas sufficiently that the amount of superheat at the inlet to the high stage compressor has the minimum possible effect on the mass flow capacity and the discharge temperature of the high stage compressor; second, provide for phase separation to prevent liquid carryover to the upper stage. Often these two objectives are at cross purposes in the physical design of the vessel.

## OPERATING DEFICIENCIES

Maximum heat transfer for desuperheating will occur with the greatest degree of mixing and contact time between the gas and liquid. One means of maximizing the contact time is to provide for a high degree of submergence. However, the greater the depth of liquid over the gas discharge outlet, the greater is the discharge head against which the booster(s) must operate. At  $-400^{\circ}\text{F}$  ( $-400^{\circ}\text{C}$ ) suction temperature and  $200^{\circ}\text{F}$  ( $-6.7^{\circ}\text{C}$ ) saturated discharge temperature, 4 ft (1.2 m) of liquid over the discharge pipe adds 1.5% to the specific power consumption in hp/ton (kW/kW) for an ammonia screw booster and 1.8% in an ammonia reciprocating booster. Alternatively, the degree of submergence can be reduced if the gas can be uniformly distributed throughout the vessel cross-section and broken up into small bubbles.

## GRAVITY SEPARATOR DESIGN

The design criteria for gravity liquid separators dictate that for a given separating distance, liquid carryover will be limited to the smallest size droplets when the vapor velocity is the lowest (Miller 1971) (Wu 1984). This, of course, suggests the choice of large diameter vessels for phase separation.

However, the greater the separating vessel diameter, the more difficult it is to cause the gas to flow horizontally to completely fill the cross section of the shell. This is because the buoyant forces predominate as the horizontal momentum component diminishes with reduced radial velocity. Therefore, for a given vapor flow there is an optimum shell diameter which when exceeded requires greater submergence to achieve the same mixing.

To this end conventionally designed GLC's use combinations of gas distribution techniques including baffles, turning vanes and slotted dispersion plates in an attempt to direct the flow horizontally to maximize vapor-liquid contact in a minimum depth of liquid. Of course, all of these devices add to the flow resistance of the gas in the GLC, which merely goes to offset the gains achieved by operating with reduced static heads from the lower liquid levels.

Figure 3 illustrates one typical design employed to optimize dispersion and mixing. The nozzle pressure loss alone in such a configuration would be at least 1.25 - 1.5 velocity heads. Richards (1985) discusses other problems associated with the operation of GLC's of this design in addition to the flow resistance, including localized high vapor velocities and gas superheating, and recommends a liquid spray with a temperature controlled liquid regulating valve providing a supply of high pressure liquid for cooling the gas on demand. He also recommends that the spray be into the inlet pipe ahead of the GLC which is an excellent scheme. But great care must be taken in the design of the spray to assure adequate mixing for optimum gas cooling.

## PUMP RECEIVERS

Almost universally, low temperature plants utilizing two-stage compression will also have a number of high temperature loads that will be accommodated by the high stage compressors of the plant. In order to minimize the capital investment for the plant the GLC is almost universally also designed to serve as the pump receiver for the circulating pumps for the high temperature loads. Such double-duty adds other potential operational difficulties to the plant.

The presence of gas bubbles in the liquid will tend to promote pump cavitation. Also, the required minimum liquid levels for pump suction inlet submergence, separation of the booster gas outlet from the pump inlet, minimum submergence of the gas discharge and the ballast requirements for evaporator start-up supply will more than double the normal operating liquid inventory in the vessel, often resulting in the need for a larger vessel in addition to the greater refrigerant inventory for the plant (Figure 4). However, the addition of pumps to the GLC affords an opportunity to eliminate the deficiencies in the conventional GLC design.

## IMPROVED GAS COOLER DESIGN

Recommended practice in pump application is to provide a by-pass flow control so that a non-flow condition will not occur even should the pump be "dead-headed". The minimum amount of flow required is determined by the part-load NPSH characteristics of the pump such as shown in Figure 5. The minimum flow should never be less than that

corresponding to the minimum NPSH. As the by-pass flow is required as a necessary part of the installation of the pump in any event, consideration can be given to applying that flow stream to some useful purpose, such as gas cooling.

An example of the application would be a typical grocery distribution cold store in the United States which might comprise 3,000,000 ft<sup>3</sup> (85,000 m<sup>3</sup>) of which one-third would be storage for frozen goods and the balance would be devoted to higher temperature storage for meats, dairy and produce. The refrigeration requirements for the high temperature plant would be approximately 300 ton (1053 kW). A liquid circulating system with a circulating ratio of 4:1 would require an ammonia liquid flow of 80 gpm (5 l/s).

One manufacturer of hermetic refrigerant pumps specifies a minimum (by-pass) flow of 40 gpm (2.7 l/s) for that pump to provide the 80 gpm (5 l/s) net delivery. The recommended installation of the by-pass flow control orifice (Q<sub>min</sub>) is as shown in Figure 6.

The 1,000,000 ft<sup>3</sup> (28,000 m<sup>3</sup>) frozen goods cold store would have a refrigeration requirement of approximately 85 ton (300 kW). Even under the most extreme conditions of booster compressor operation, the gas cooling load would not exceed 25 ton (88 kW). The liquid flow required to effect that cooling at 20°F (-6.7°C) would be only 1.7 gpm (0.34 l/s). Clearly, significantly larger loads or even very much smaller high temperature pumps would be in a proportion such that the Q<sub>min</sub> flow would still be capable of providing all of the gas cooling requirements.

Therefore, any two-stage plant with additional high temperature loads that use a pump circulation delivery system could utilize the Q<sub>min</sub> flow stream to achieve the gas cooling.

A method for doing so that eliminates the need for submergence of the booster discharge gas pipe also eliminates the static head penalty and the flow restrictions imposed by the various gas distribution and dispersion schemes.

Richards (1985) recommended performing the gas cooling in the inlet pipe to the GLC so that the possibility of reheating the gas is eliminated. It only remains to devise a method that assures adequate heat transfer to effectively cool the gas stream to near saturation in the inlet pipe. Figure 7 illustrates a design that accomplishes the cooling by substituting an atomizing spray nozzle for the Q<sub>min</sub> orifice in the conventional pump installation. This design provides several added benefits as well. Eliminating the submerged gas inlet also provides unperturbed liquid delivery to the pump suction inlets. The quiescent liquid allows easier separation and settling of oil resulting in lower oil content in the liquid delivered to the plant. Liquid inventory in the vessel is reduced and use of the low velocity inlet nozzle reduces nozzle flow losses.

Figure 8 illustrates how the system can be installed to provide accessibility for inspection and maintenance or for modification should future plant design requirements dictate. Such a cooling arrangement has been designed and installed in a meat plant and in a citrus plant in the United States with very satisfactory results.

#### REFERENCES

Miller, D. K., "Design and Application Guide for Gravity Gas and Liquid Separators, Suction Traps and Low Pressure Accumulator - Receivers Used in Refrigeration Systems", York Division, Borg-Warner Corporation Engineering Report, November, 1971.

Richards, William V., "A Critical Look at Old Habits in Ammonia Vessel Specifications", Proceedings of the IIAR Seventh Annual Meeting, San Antonio, TX, March, 1985.

Wu, F. H., "Drum Separator Design - A New Approach", Chemical Engineering, pp. 74 - 80, April, 1984.

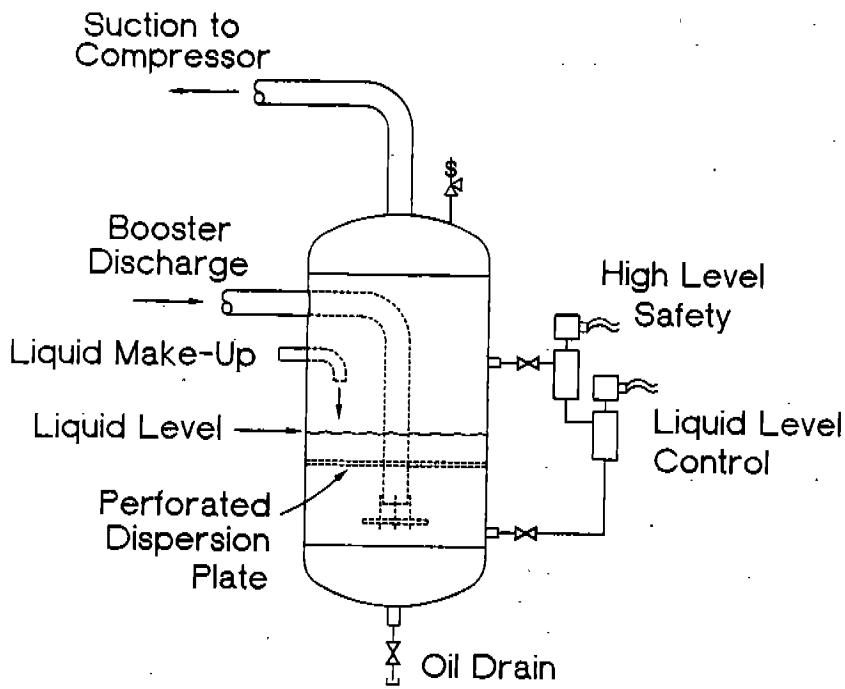

Conventional Design  
Flooded Gas Cooler

Figure 1

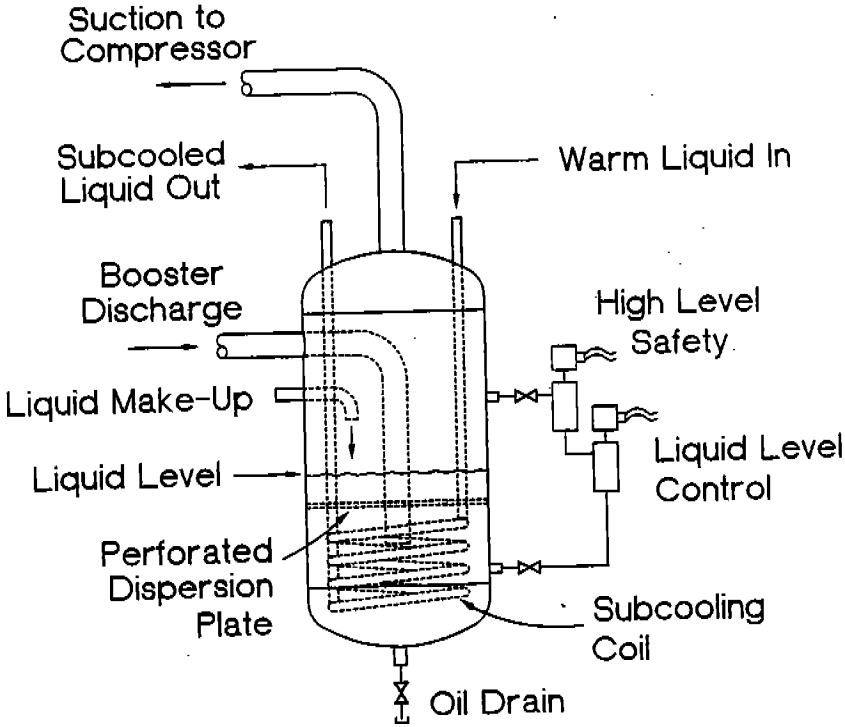

Flooded Gas Cooler With  
Liquid Subcooling Coil

Figure 2

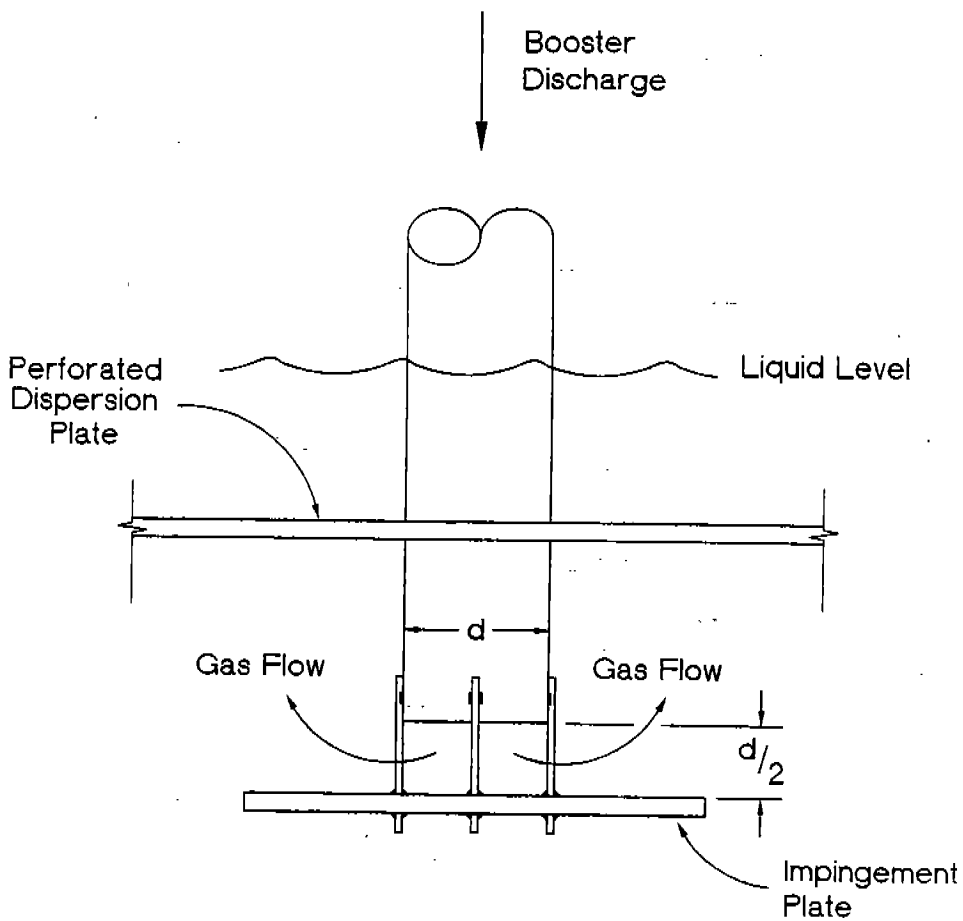

Flooded Gas Cooler  
Gas Dispersion Technique

Figure 3



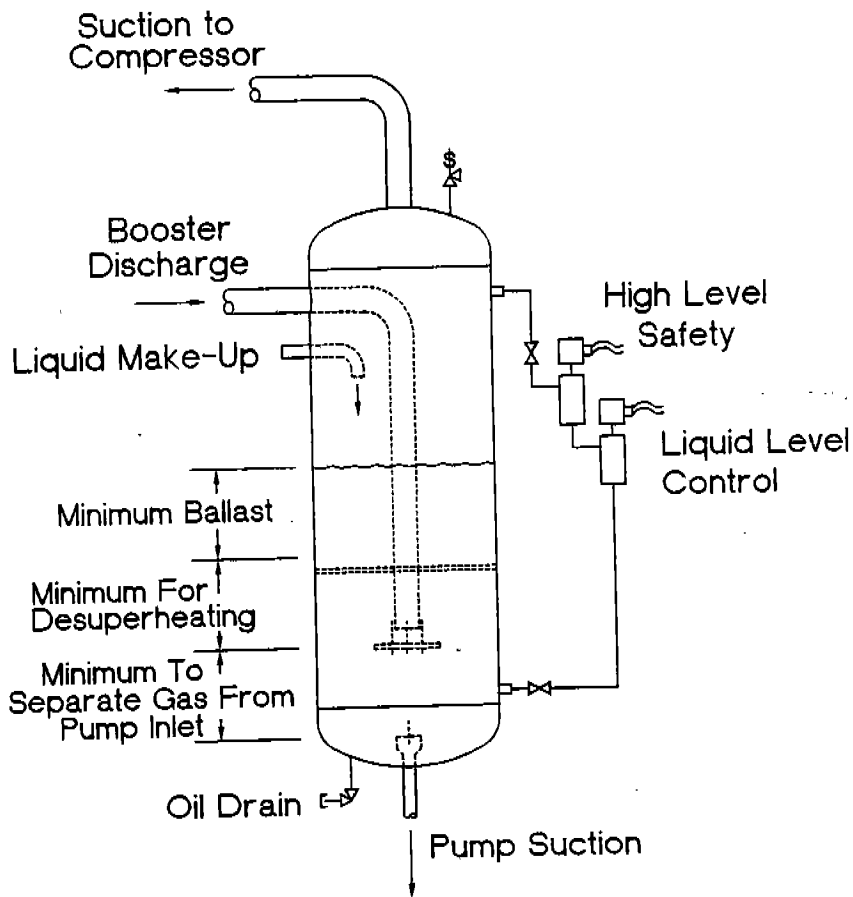

Conventional Flooded Gas Cooler Used As Pump Receiver

Figure 4

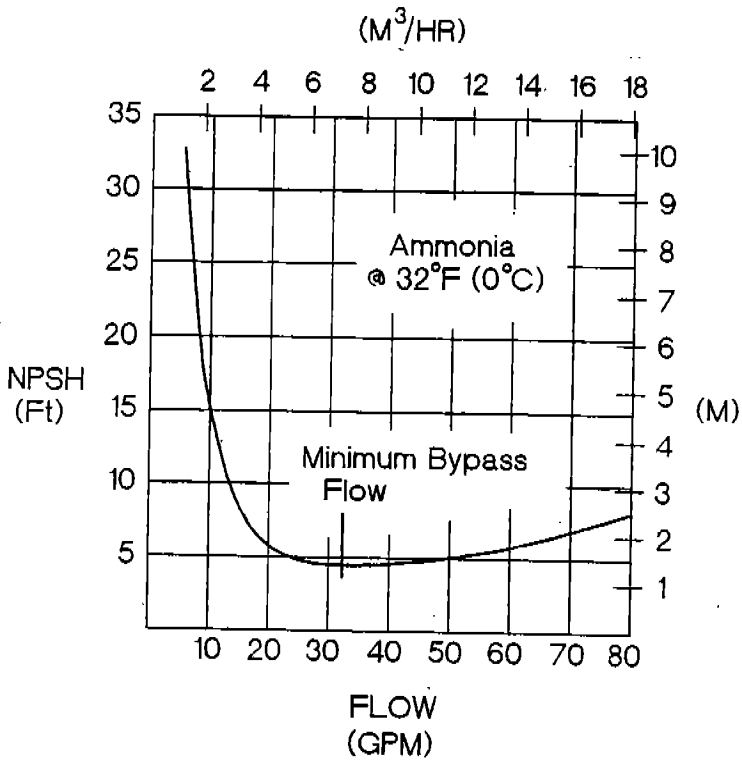

NPSH vs Flow in  
Hermetic Centrifugal Pump

Figure 5

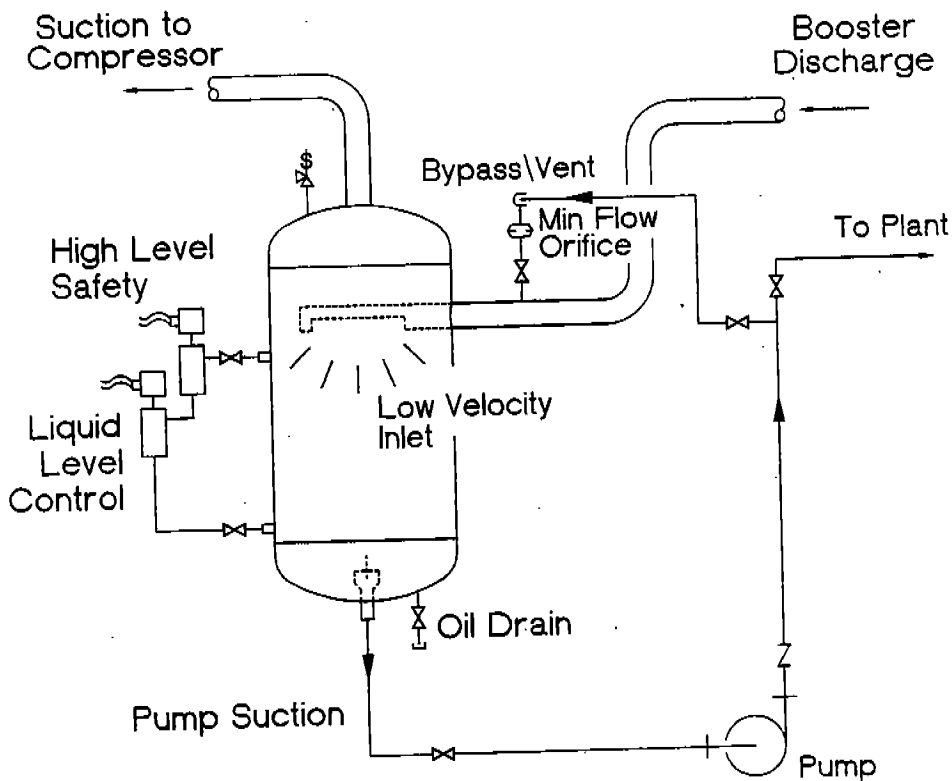

Pump Manufacturer's  
Recommended Installation  
of Minimum Flow Orifice

Figure 6

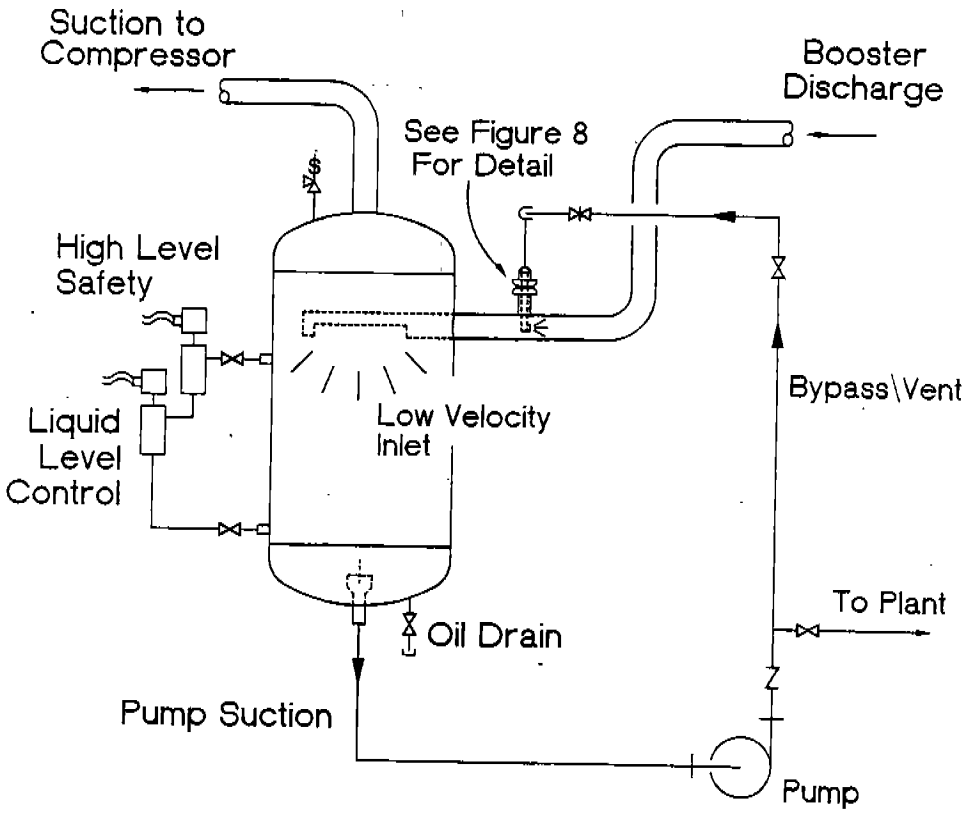

Pump Installation With  
Liquid Spray Nozzle For  
Minimum Flow Orifice

Figure 7

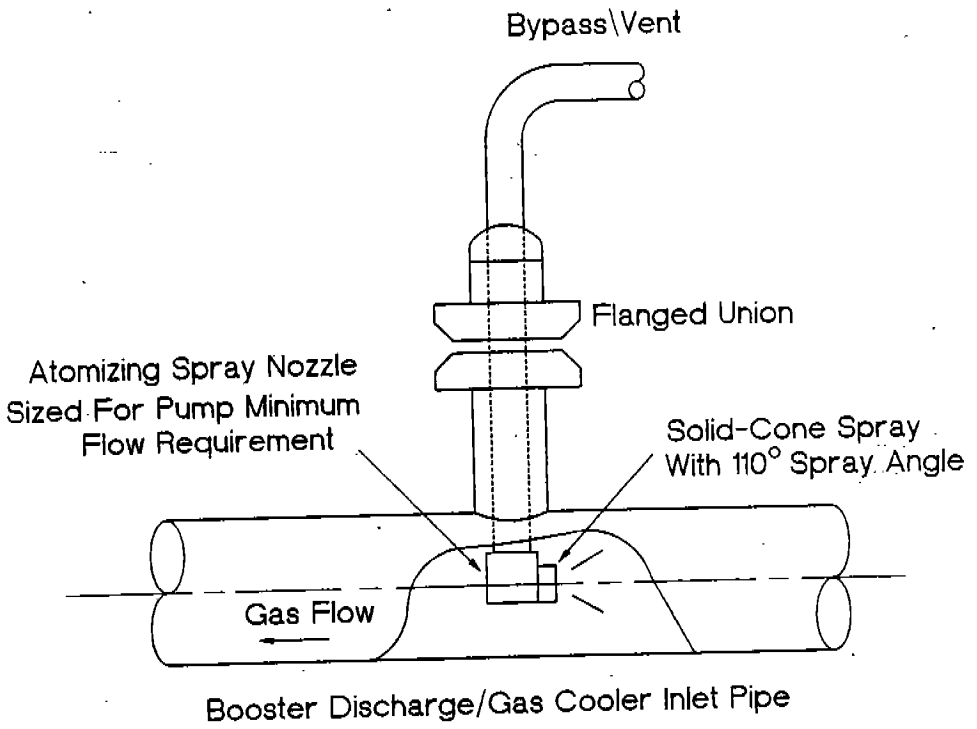

Detail of Liquid Spray

Figure 8