

Purdue University

Purdue e-Pubs

Historical Documents of the Purdue
Cooperative Extension Service

Department of Agricultural Communication

2-1-1963

Free Stalls for Dairy

Purdue University Cooperative Extension Service

Follow this and additional works at: <https://docs.lib.purdue.edu/agext>

Agricultural Engineers' Digest

Purdue University Cooperative Extension Service, "Free Stalls for Dairy" (1963). *Historical Documents of the Purdue Cooperative Extension Service*. Paper 70.

<https://docs.lib.purdue.edu/agext/70>

For current publications, please contact the Education Store: <https://mdc.itap.purdue.edu/>

This document is provided for historical reference purposes only and should not be considered to be a practical reference or to contain information reflective of current understanding. For additional information, please contact the Department of Agricultural Communication at Purdue University, College of Agriculture: <http://www.ag.purdue.edu/agcomm>

This document has been made available through Purdue e-Pubs, a service of the Purdue University Libraries. Please contact epubs@purdue.edu for additional information.

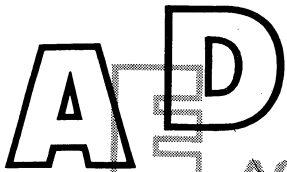

FREE STALLS FOR DAIRY

AGRICULTURAL ENGINEERS' DIGEST

INTRODUCTION

Free stalls are an alternative to the typical bedded area and manure pack for cows in the loose housing system. The cows are not restrained nor is feed offered in the stalls.

GENERAL

Both stall barns and open resting areas have been converted.
Provide a stall for each animal.
Do not feed or water in stalls.
Arrange space for power cleaning.

SEVERE CLIMATES

Typical loose housing bedded areas provide warmth for the cows on the manure pack. With free stalls, insulated and ventilated buildings with cow-operated doors may be required.

MODERATE CLIMATES

Use free stalls in open-front resting sheds.

REPORTED ADVANTAGES

Bedding costs may be reduced up to 75% compared with a conventional bedded area not carefully managed. Less labor is required to clean & bed stalls compared with a conventional bedded area given daily care. Cows are cleaner, requiring less cow-washing time. Resting area requirement is less.

60-80 sq. ft./cow in conventional loafing sheds.
Down to 50 sq. ft./cow in stall housing.

COW INTRODUCTION

A few days may be necessary to acquaint the animals with this system of housing. During this period:

Fill bedded area about half full to prevent cows from kicking the bedding into the alley.

Cows may rest in the alley.

Tie the resisting animals (2% to 3% of herd, usually older cows) in the stalls for a few nights.

After the animals are acquainted with the stalls:

Fill the bedded area to almost full height of curb. Add bedding as required.

CLEANING

Remove manure from the bedding and curb twice a day.

A good time for one cleaning is in the morning right after the animals get up.

The average cleaning time is 20 minutes per day for a 50-cow herd. Little bedding will need to be added. Scrape alleys at least once a day. Some operators flush the alleys with water.

MANURE DISPOSAL

Facilities for handling sloppy manure with little bedding are required.

A manure loading ramp and an end gate on the manure spreader, or a liquid manure tank, have proven satisfactory.

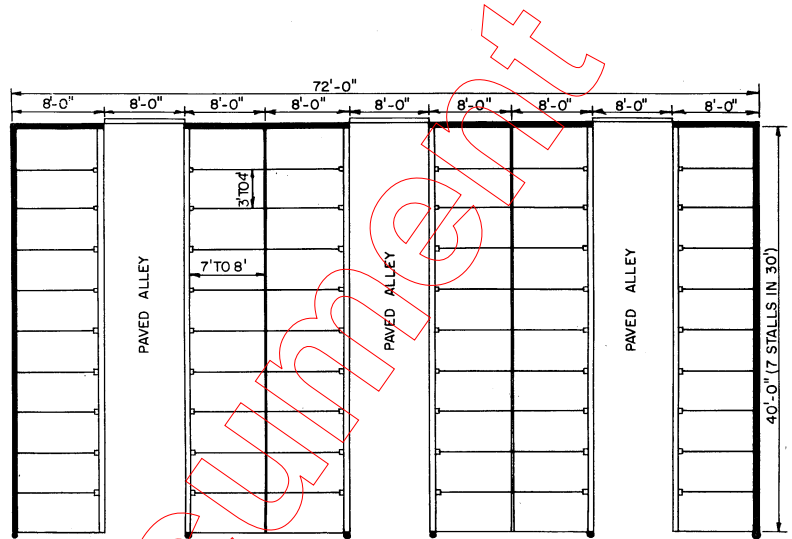

6 ROW, SIDE OPENING

This arrangement for a typical open-front shed has rear doors to prevent winter drafts. Drive-through alleys simplify cleaning. A wider building, or large cleaning equipment, may require wider alleys.

In severe climates, close the open front along the stalls.

VENTILATION

Ventilation is essential to prevent condensation. Gable-end louvers, openings under eaves, openings in walls, etc. provide ventilation.

In severe climates, large openings should be on only one side of the building to prevent drafts.

In moist climates, a solid or insulated roof deck will reduce condensation.

ALLEY

The alley should be paved and 8' or wider to accommodate cleaning equipment.

No slope across width to improve scraping.

Slope alley 1"/10' in direction of manure movement, or both ways from the center of a long (over 60') alley.

If water flushing is used, a concrete curb is necessary.

CURB

8" above alley, 4"-6" wide.

Concrete or pressure-treated plank on edge.

CONFINEMENT PENS

One or two stalls may be provided to confine cows in heat and for artificial breeding. Stalls and maternity pens adjacent to the milking area are preferred.

STALL DIMENSIONS

- Large breeds - 4' x 7½' or 8'
- Small breeds - 3½' x 7' or 7½'
- Heifers - 3½' to 4' x 7'
- Calves - 2½' to 3' x 5'

STALL FLOOR

Stall floor is dirt, sand, or gravel plus deep bedding.

PARTITIONS - Homemade or Commercial

4' high above curb.
 Solid partitions starting at floor level reduce drafts, but partitions with members spaced up to 12" apart are cheaper and provide better summer air movement. Semi-open partitions start 18"-20" above floor level so legs will not get caught. Slant alley post inward 1' to 2' or set alley post back from alley to facilitate cleaning.

POSTS

- 4" x 4" or 4" x 6" wood post.
- 2½" standard pipe.

BRISKET BOARD

A front curb or brisquet board at the same level as the rear curb prevents the cow from moving too far forward when resting. Space 5' from rear curb for small animals and 6' for large animals.

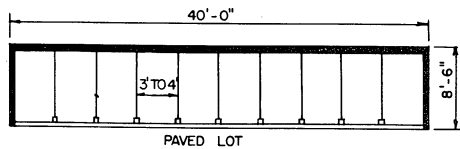

1 ROW, SIDE OPENING

The single row of stalls can be built along a windbreak. This arrangement might be suitable for heifer facilities in milder climates.

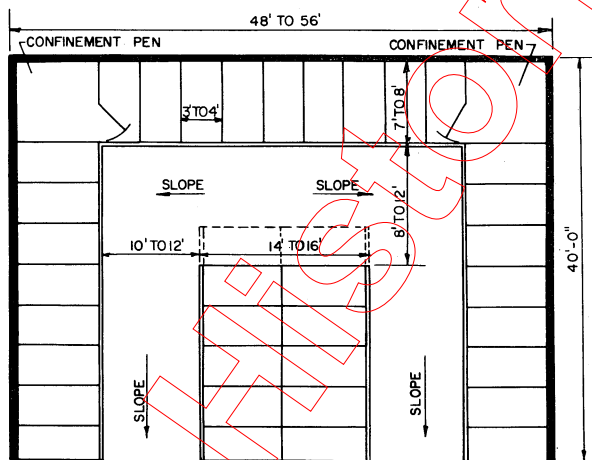

U-ARRANGEMENT

This arrangement has only 35 stalls; a drive-through plan would have 40 stalls. An 8' cross alley would provide two more stalls but would probably require hand cleaning.

PIPE

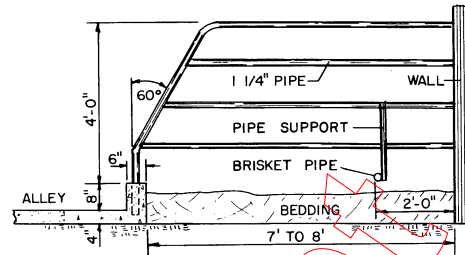

SPACED BOARDS

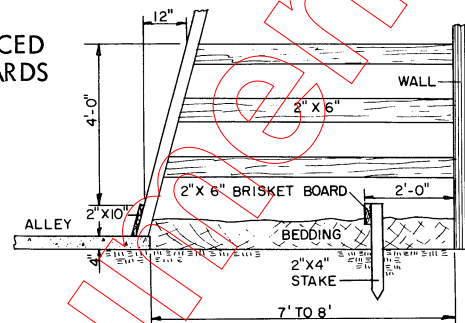

SOLID

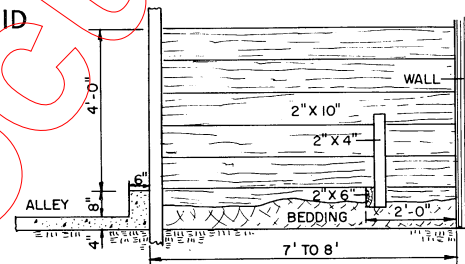

1 ROW

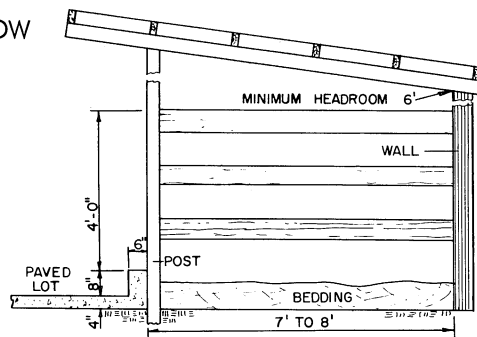

2 ROW, END OPENING

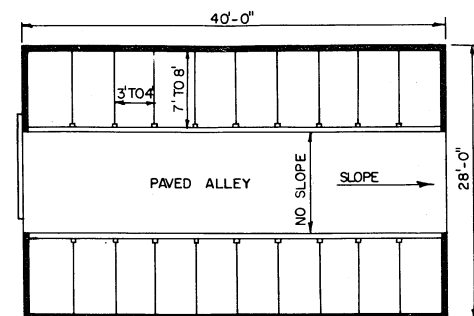

Stalls can be arranged along a central alley in a narrow building. A door at one end will reduce winter drafts.